



Eengezinswoning bnr 9

Verkooptekeningen



Renvooi materialen



dakpan kleur 1

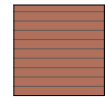

metselwerk kleur A

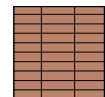

metselwerk kleur B



rockpanel kleur C

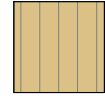

rabatdelen kleur D

Renvooi bouwkundig



entree woning



entree berging



metselwerk

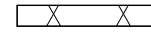

isolatie



dragende wand



niet dragende binnenwand

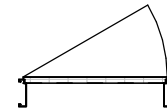

binnendeurkozijn (met bovenlicht)

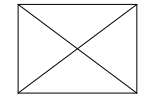

kruipluik

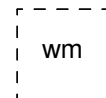

opstelplaats wasmachine

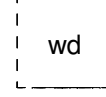

opstelplaats wasdroger

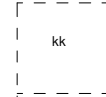

opstelplaats koelkast

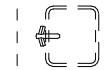

principe opstelling keukenblok



onbenoemde ruimte volgens krijtstreepmethode

Renvooi installaties



aansluitpunt licht, wand



centraaldoos met lichtpunt



armatuur aan de wand



rookmelder



aansluitpunt niet bedraad / loos



beldrukker



schel



schakelaar, 1-polig



driestandenschakelaar tbv wtw



schakelaar, wissel



schakelaar, serie



pulsschakelaar tbv warmteterugwinunit



wandcontactdoos 1-voudig met beschermingscontact



wandcontactdoos 2-voudig met beschermingscontact



thermostaatleiding, bedraad



wandcontactdoos tbv warmteterugwinunit



wtw mechanische ventilatie-unit incl. warmteterugwinunit



wp warmtepomp



inblaasventiel mechanische ventilatie



afzuigventiel mechanische ventilatie



inblaasventiel mechanische ventilatie



afzuigventiel mechanische ventilatie



inblaasventiel mechanische ventilatie



afzuigventiel mechanische ventilatie



inblaasventiel mechanische ventilatie



afzuigventiel mechanische ventilatie



inblaasventiel mechanische ventilatie



afzuigventiel mechanische ventilatie



inblaasventiel mechanische ventilatie



afzuigventiel mechanische ventilatie



inblaasventiel mechanische ventilatie



afzuigventiel mechanische ventilatie



inblaasventiel mechanische ventilatie



afzuigventiel mechanische ventilatie



inblaasventiel mechanische ventilatie



afzuigventiel mechanische ventilatie



inblaasventiel mechanische ventilatie



afzuigventiel mechanische ventilatie



inblaasventiel mechanische ventilatie



afzuigventiel mechanische ventilatie



inblaasventiel mechanische ventilatie



afzuigventiel mechanische ventilatie



inblaasventiel mechanische ventilatie



afzuigventiel mechanische ventilatie



inblaasventiel mechanische ventilatie



afzuigventiel mechanische ventilatie

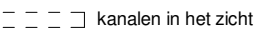

kanalen in het zicht



doucheput

Disclaimer

De op deze tekeningen aangegeven maten zijn circa maten in millimeters en tussen de wanden / vloeren gemeten, waarbij geen rekening is gehouden met enige wandafwerking, plinten, aftimmering, etc. In verband met de nauwkeurige uitwerking van details, constructie, maatvoering, materialen e.d. kunnen er kleine afwijkingen ontstaan ten opzichte van de nu vermelde gegevens. Deze geringe afwijkingen geven geen aanleiding tot verrekening. Aan de op deze tekening aangegeven maten kunnen derhalve geen rechten worden ontleend. De op deze tekeningen aangegeven maatvoering is niet geschikt voor opdrachten aan derden door koper(s). De posities van aansluitingen en installatie onderdelen zijn indicatief op tekening aangegeven. De exacte aantallen en posities zullen na berekening in het werk door de installateurs worden bepaald en kunnen afwijken van deze tekening.



Renvooi

Tekening:

Woningtype: C51

Bouwnummer: -

Bladnummer: VT-01-00

Bladformaat: A3

Schaal: -

Datum: 16-01-2024



Bwnr. 01

Bwnr. 02

Bwnr. 03

Bwnr. 04

Bwnr. 05

Bwnr. 06

Bwnr. 07

Bwnr. 08

Bwnr. 09

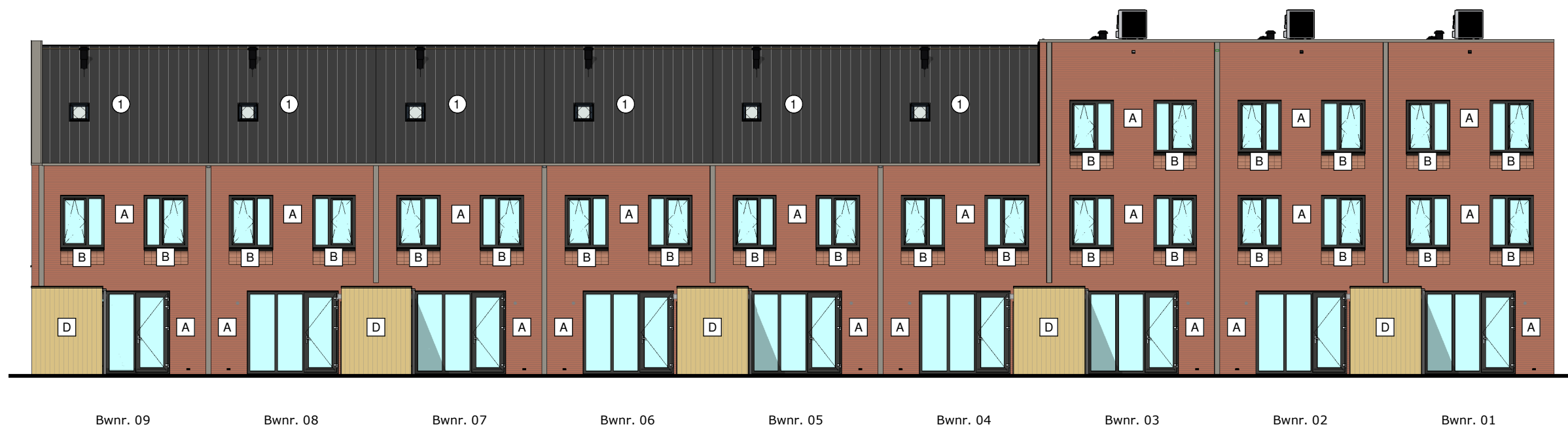

Bwnr. 09

Bwnr. 08

Bwnr. 07

Bwnr. 06

Bwnr. 05

Bwnr. 04

Bwnr. 03

Bwnr. 02

Bwnr. 01



Gevels

Tekening:

Woningtype: C51

Bouwnummer: 01 t/m 09

Bladnummer: VT-01-00a

Bladformaat: A3

Schaal: 1:150

Datum: 16-01-2024

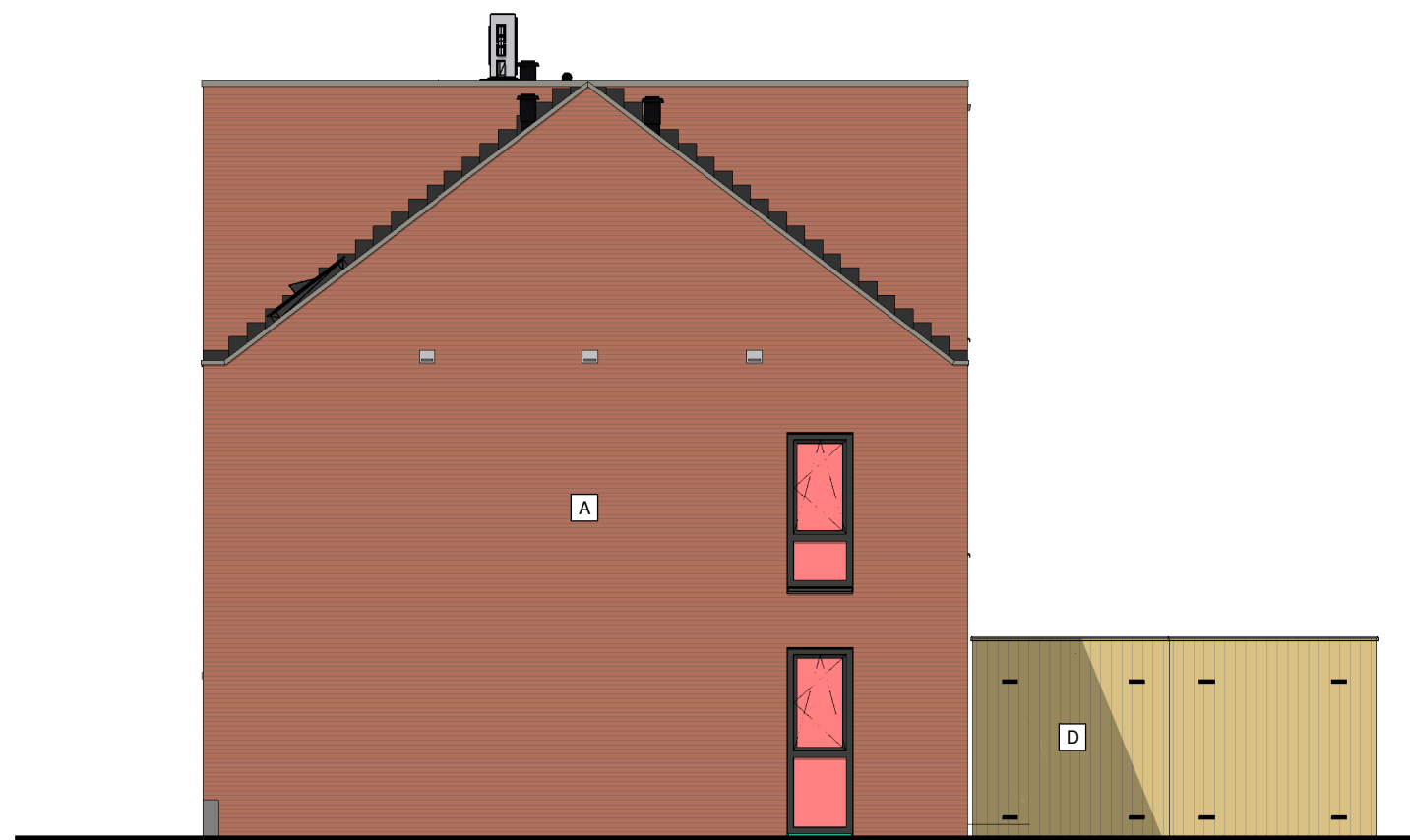

Rechter zijgevel

Bwnr. 09



Zijgevels

Tekening:

Woningtype: C51

Bouwnummer: 01 en 09

Bladnummer: VT-01-00b

Bladformaat: A3

Schaal: 1:100

Datum: 16-01-2024

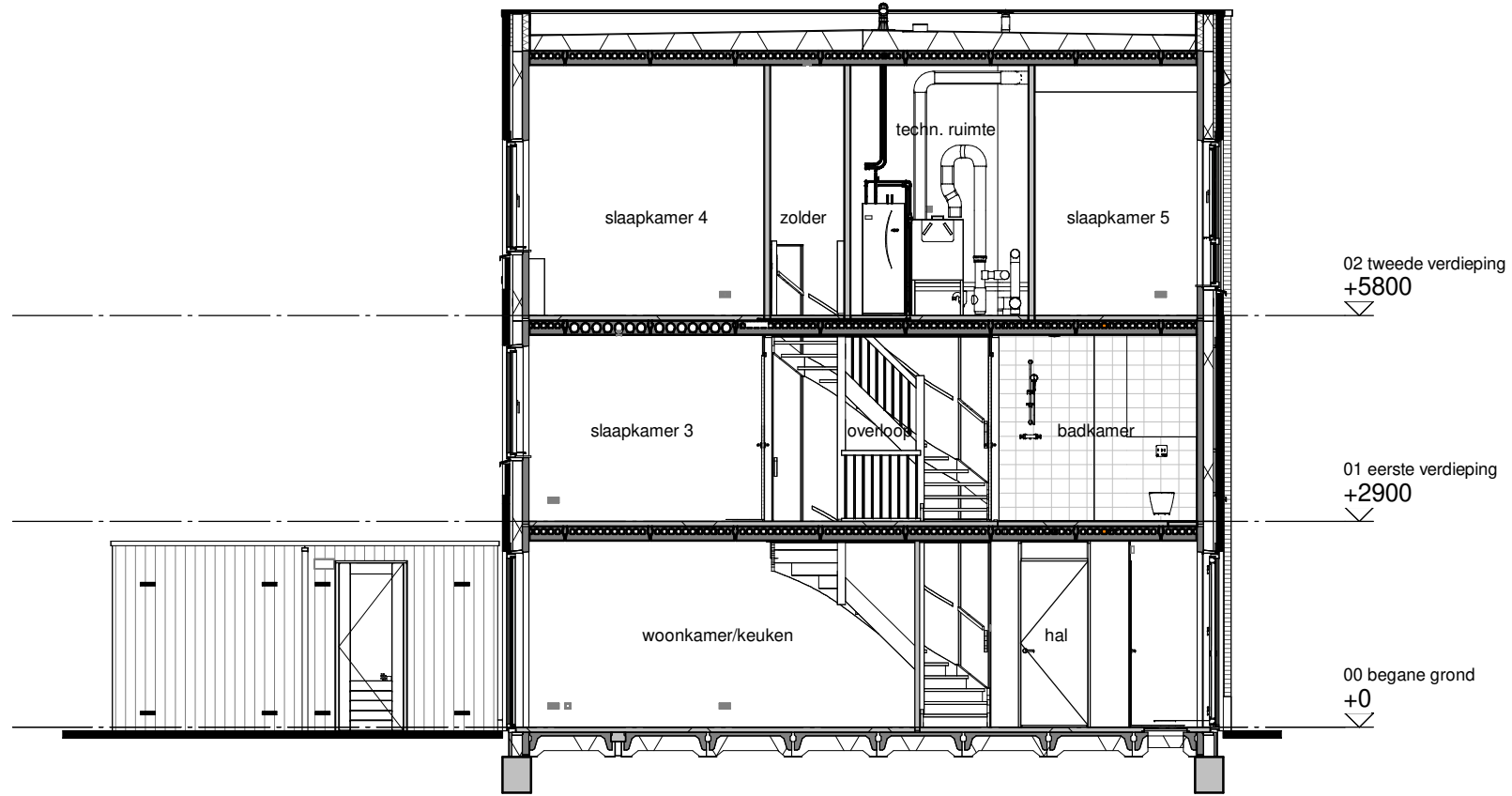

Bwnr. 03

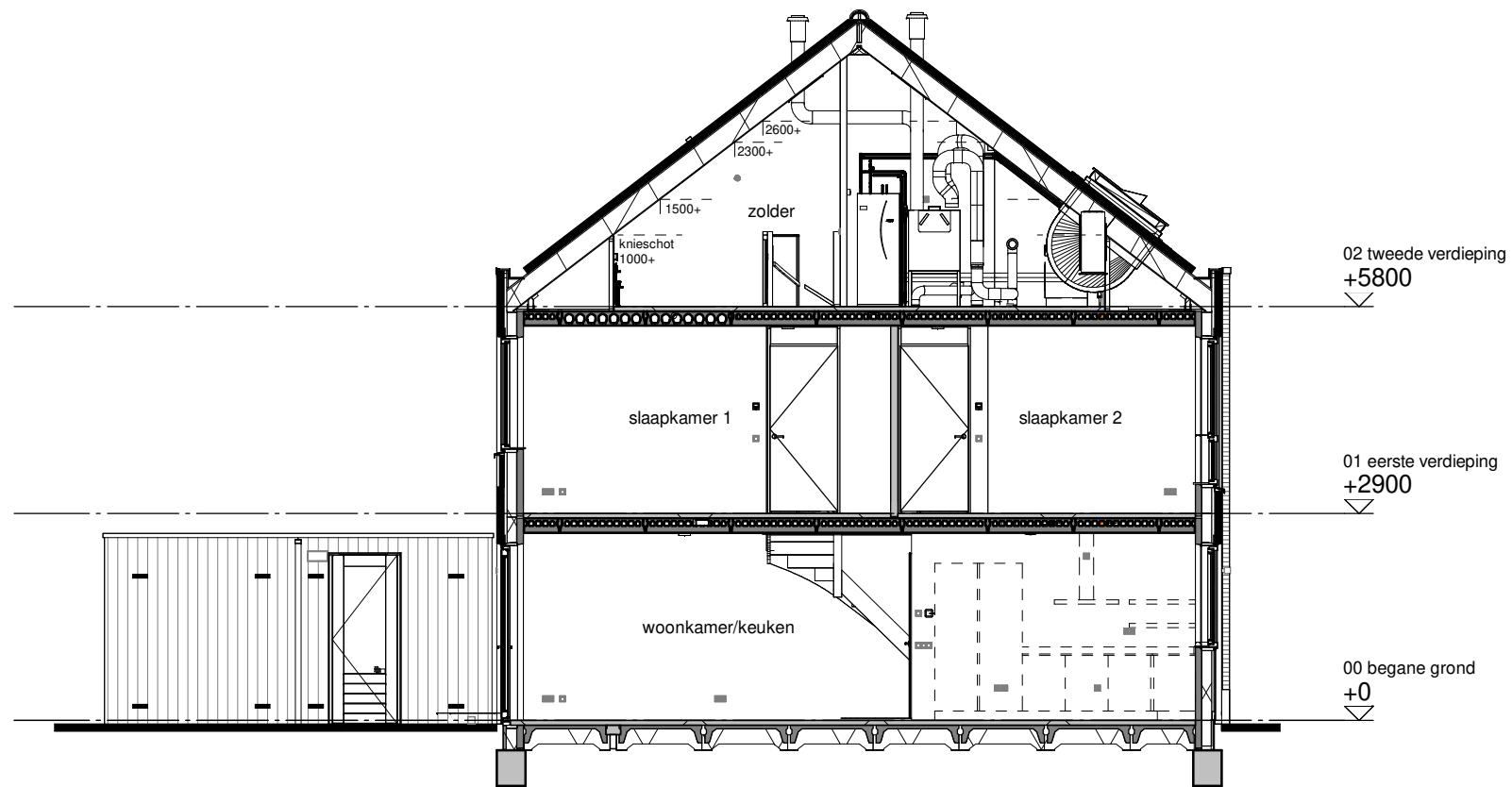

Bwnr. 04



Doorsneden

Tekening:

Woningtype: C51

Bouwnummer:

Bladnummer: VT-01-00c

Bladformaat: A3

Schaal: 1:100

Datum: 16-01-2024

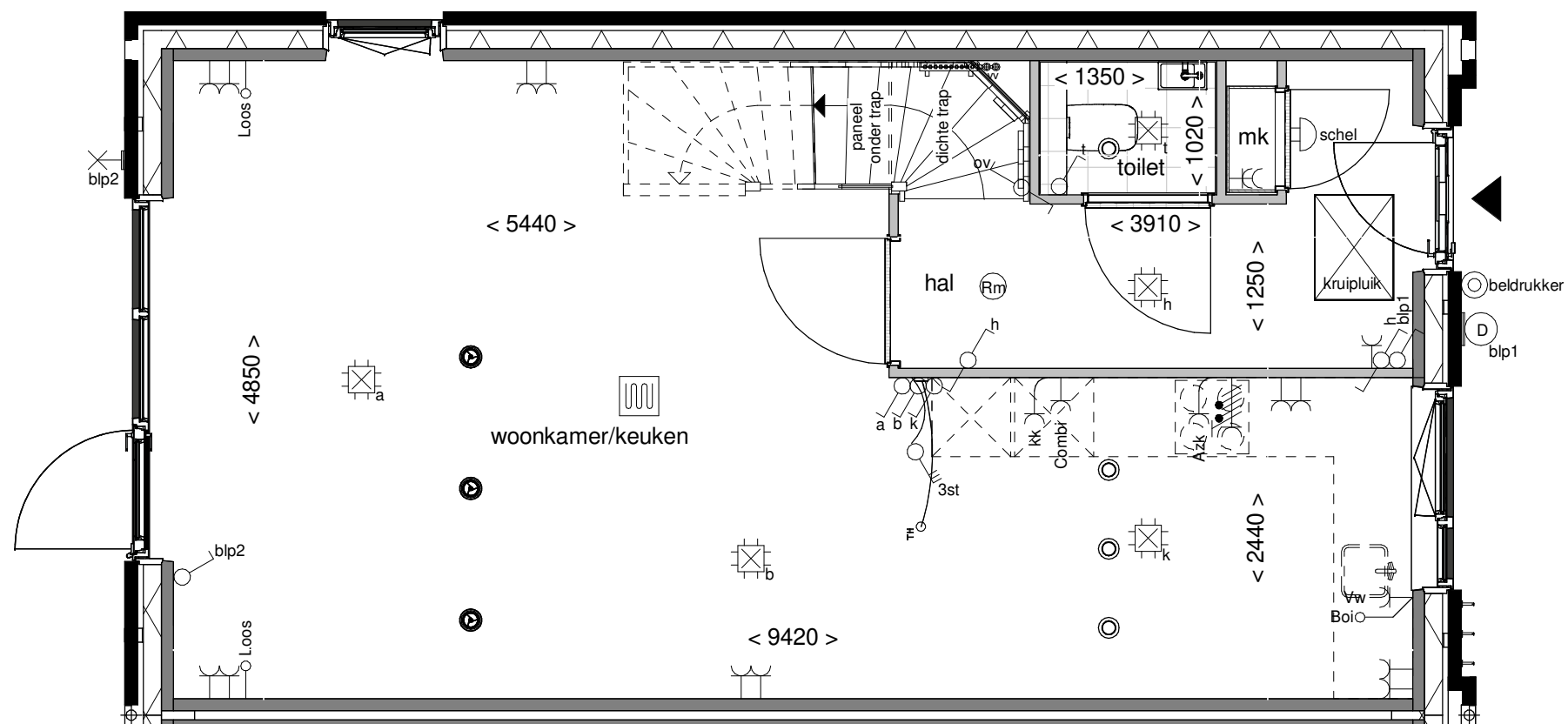
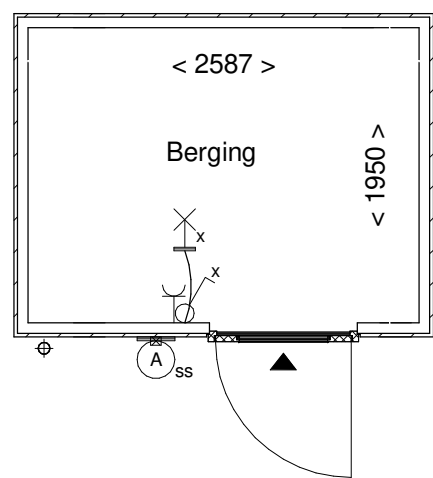

Begane grond

Tekening:	
Woningtype:	C51
Bouwnummer:	09
Bladnummer:	VT-01-09a
Bladformaat:	A3
Schaal:	1:50
Datum:	16-01-2024

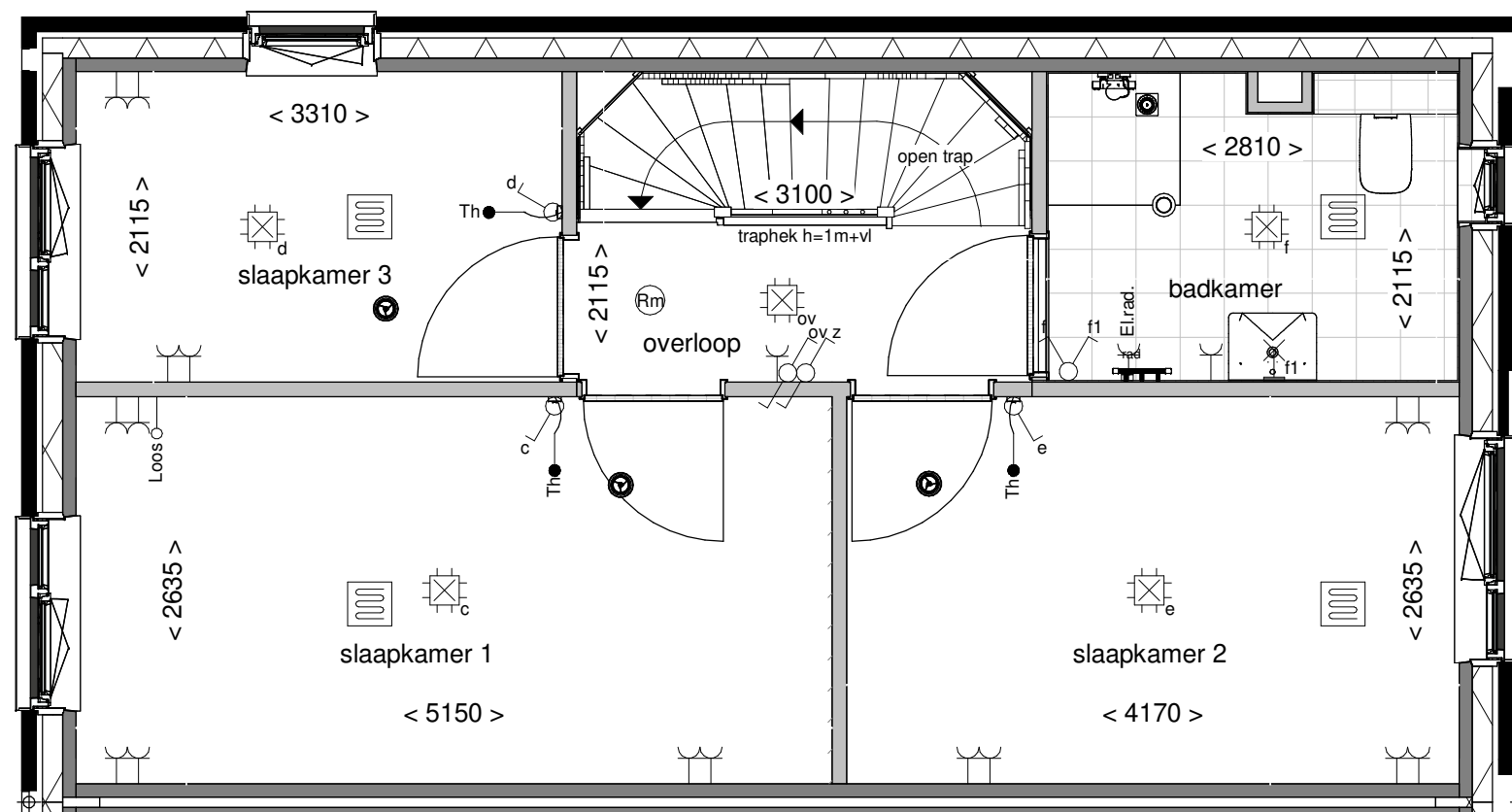
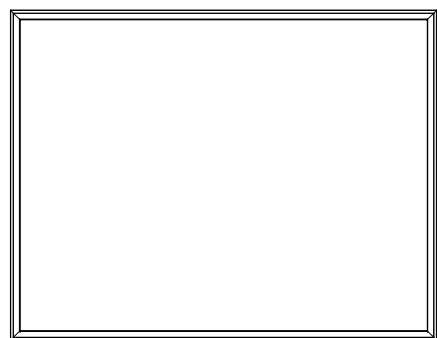

Eerste verdieping

Tekening:	
Woningtype:	C51
Bouwnummer:	09
Bladnummer:	VT-01-09b
Bladformaat:	A3
Schaal:	1:50
Datum:	16-01-2024

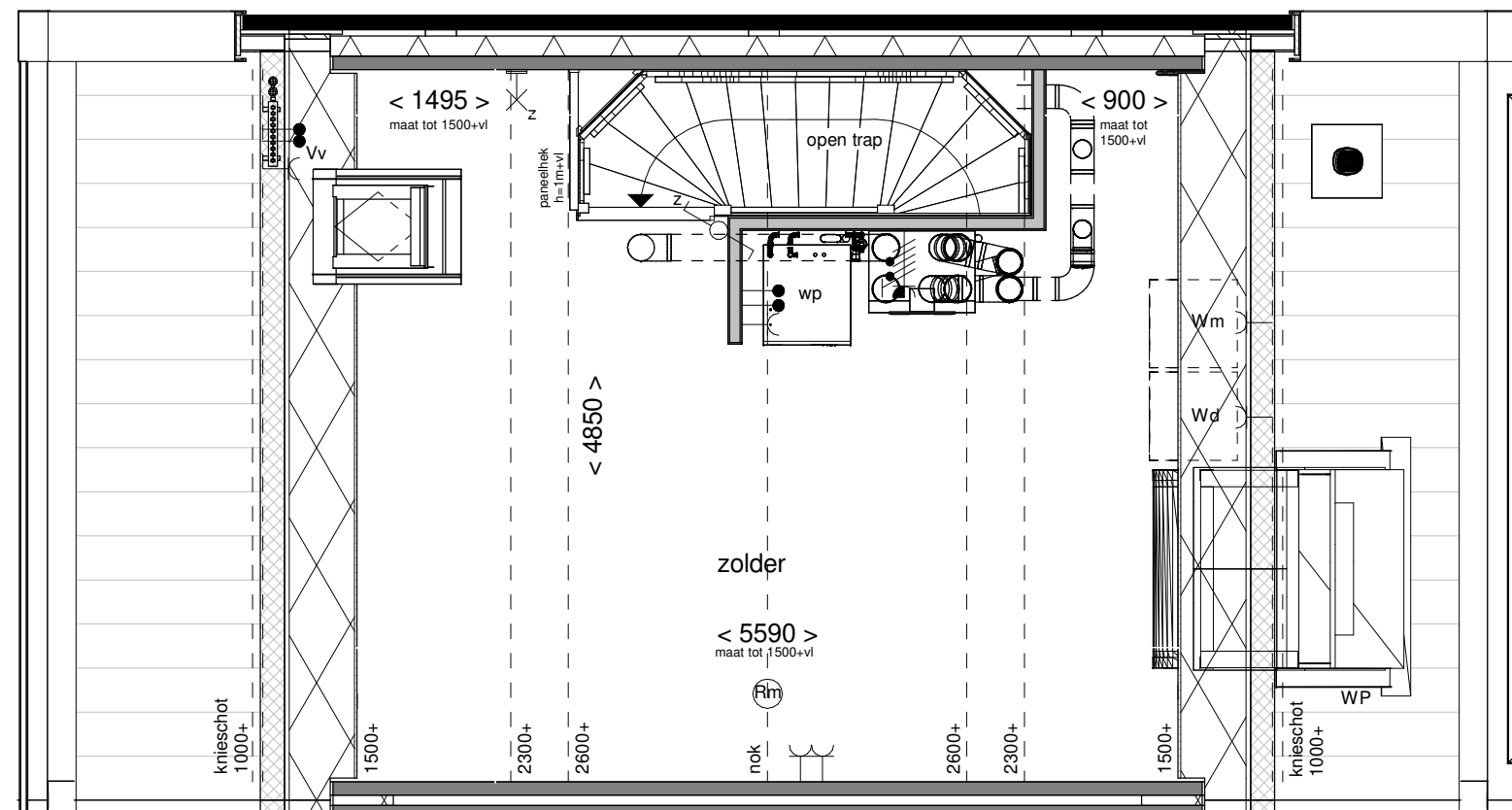

Tweede verdieping

Tekening:	_____
Woningtype:	C51
Bouwnummer:	09
Bladnummer:	VT-01-09c
Bladformaat:	A3
Schaal:	1:50
Datum:	16-01-2024

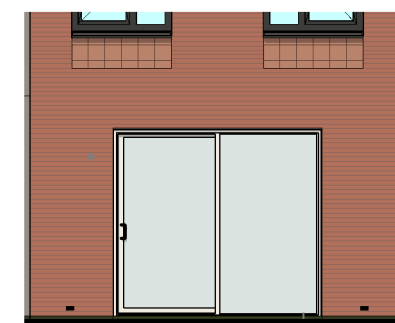
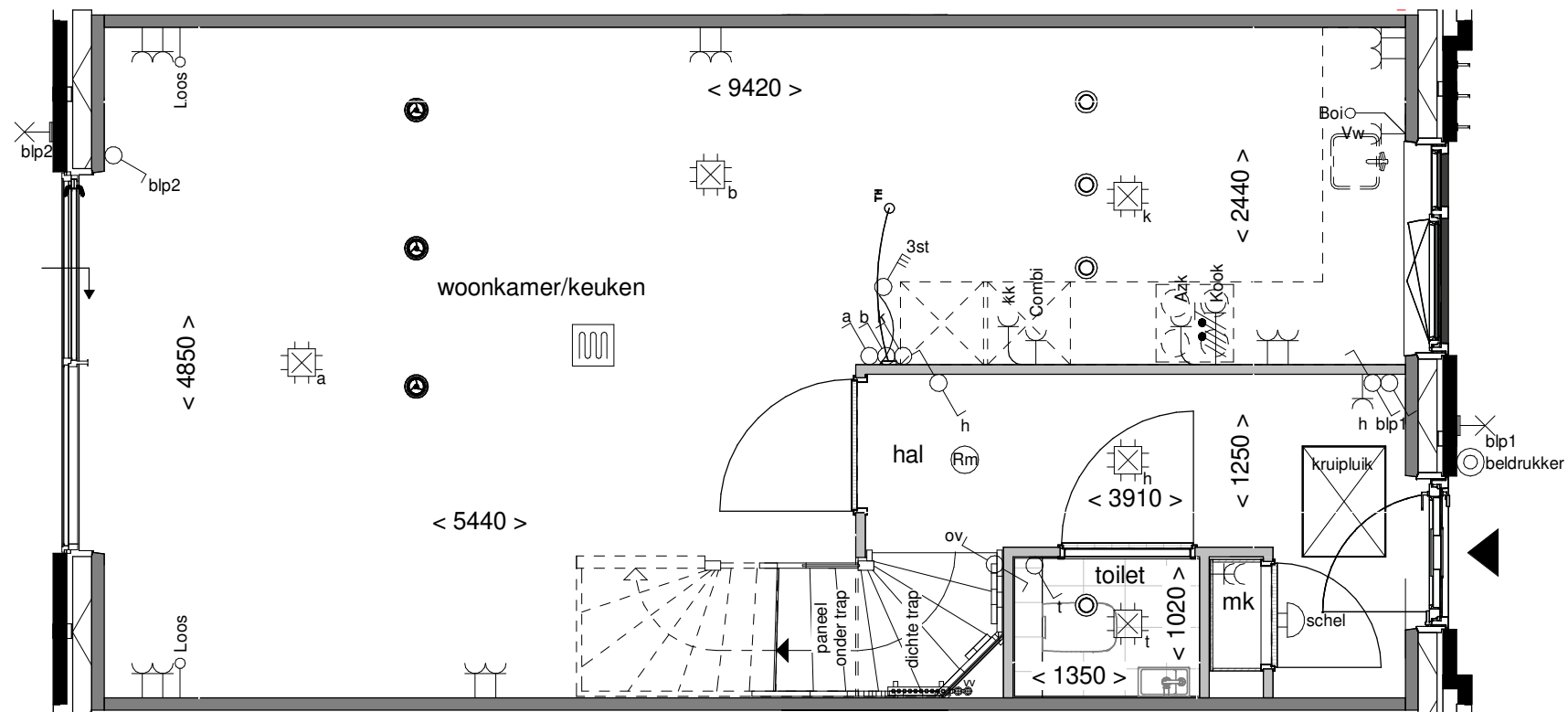

Achtergevel schaal 1:100



Tekening: Aluminium
schuifpui

Woningtype: C51

Bouwnummer: -

Optienummer: 1.A.X.52

Bladformaat: A3

Schaal: 1:50 / 1:100

Datum: 16-01-2024

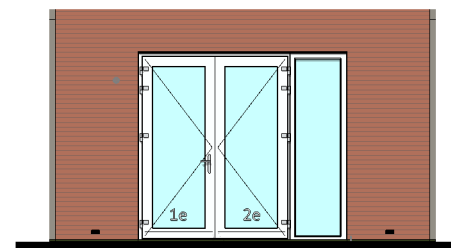
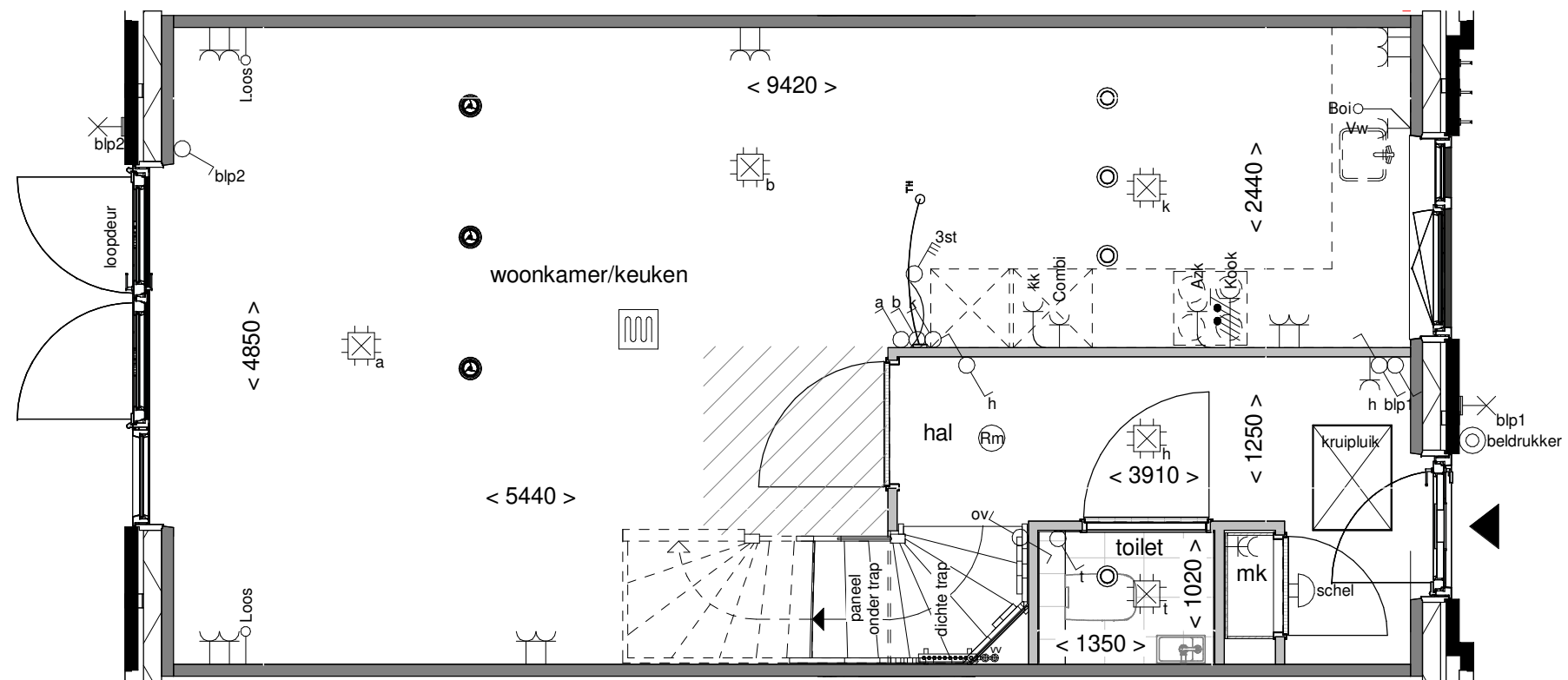

Achtergevel schaal 1:100



Tekening: Openslaande deuren 1 zijlicht

Woningtype: C51

Bouwnummer: -

Optienummer: 1.A.X.58

Bladformaat: A3

Schaal: 1:50 / 1:100

Datum: 16-01-2024

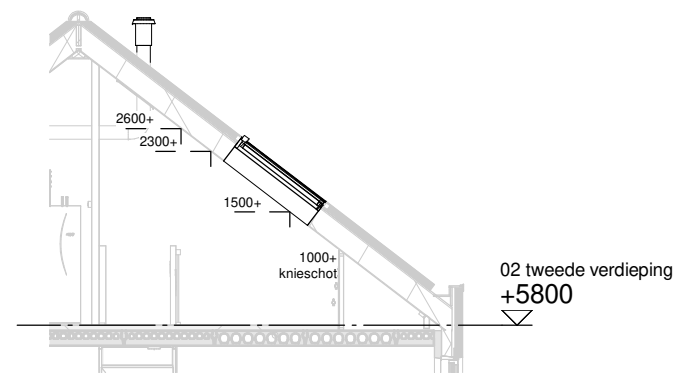
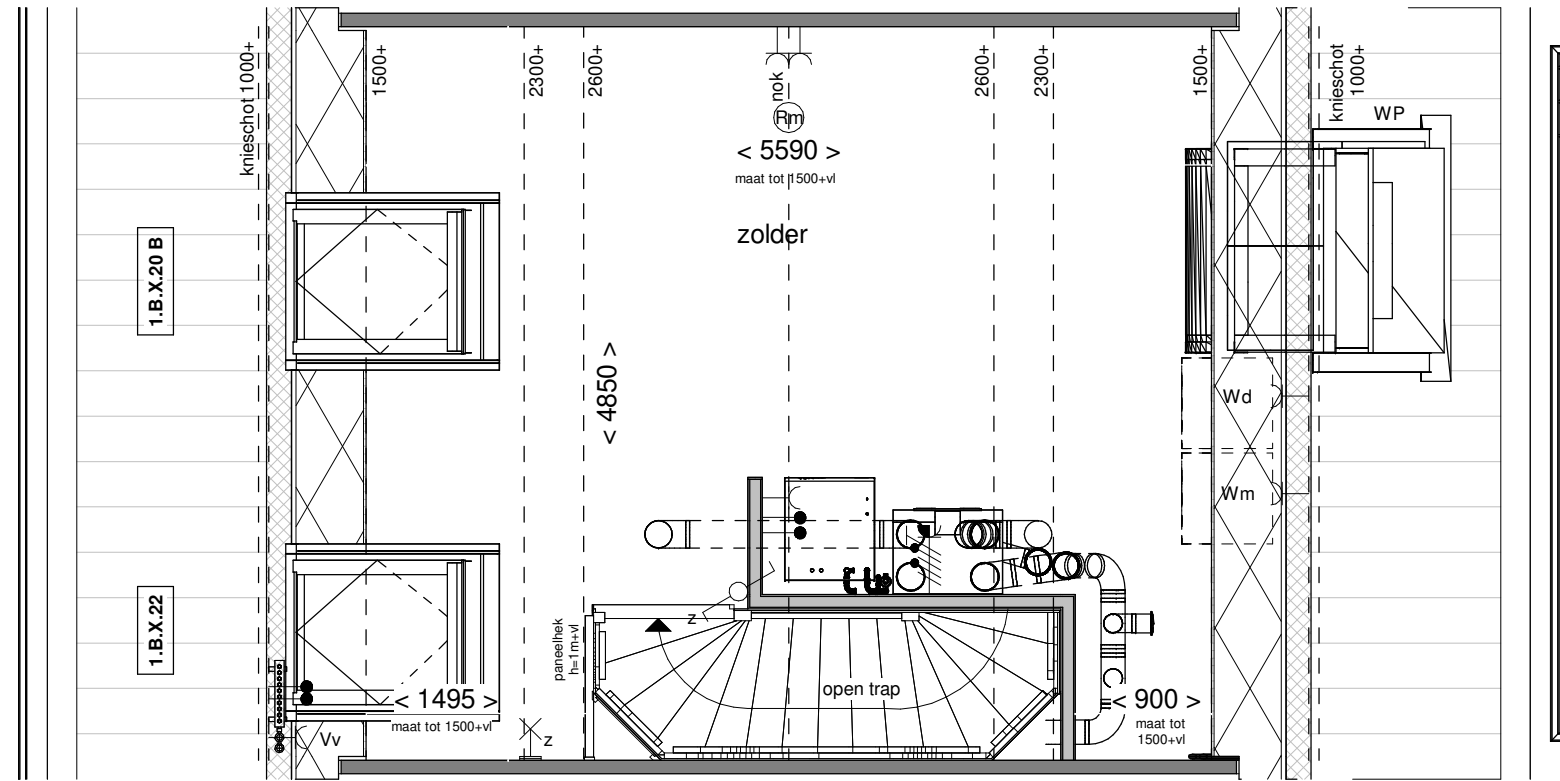

Doorsnede schaal 1:100

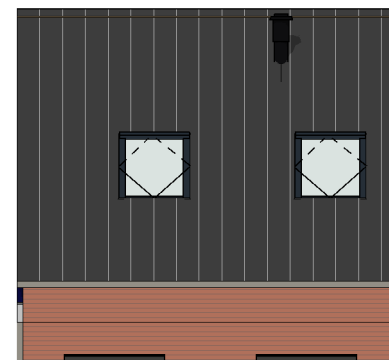

Achtergevel schaal 1:100

wij wonen

Tekening: Dakramen
achtergevel

Woningtype: C51

Bouwnummer: -

Optienummer: 1.B.X.20 / 1.B.X.22

Bladformaat: A3

Schaal: 1:50 / 1:100

Datum: 16-01-2024

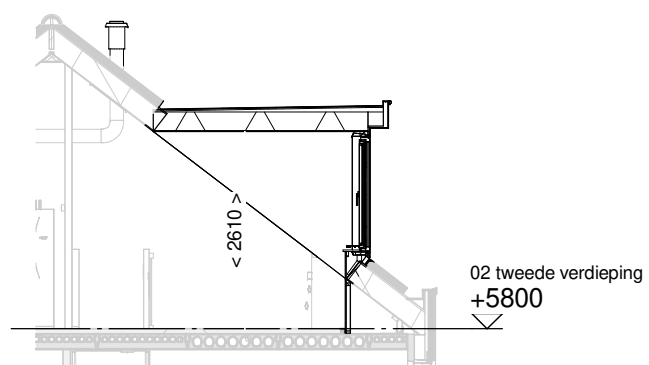
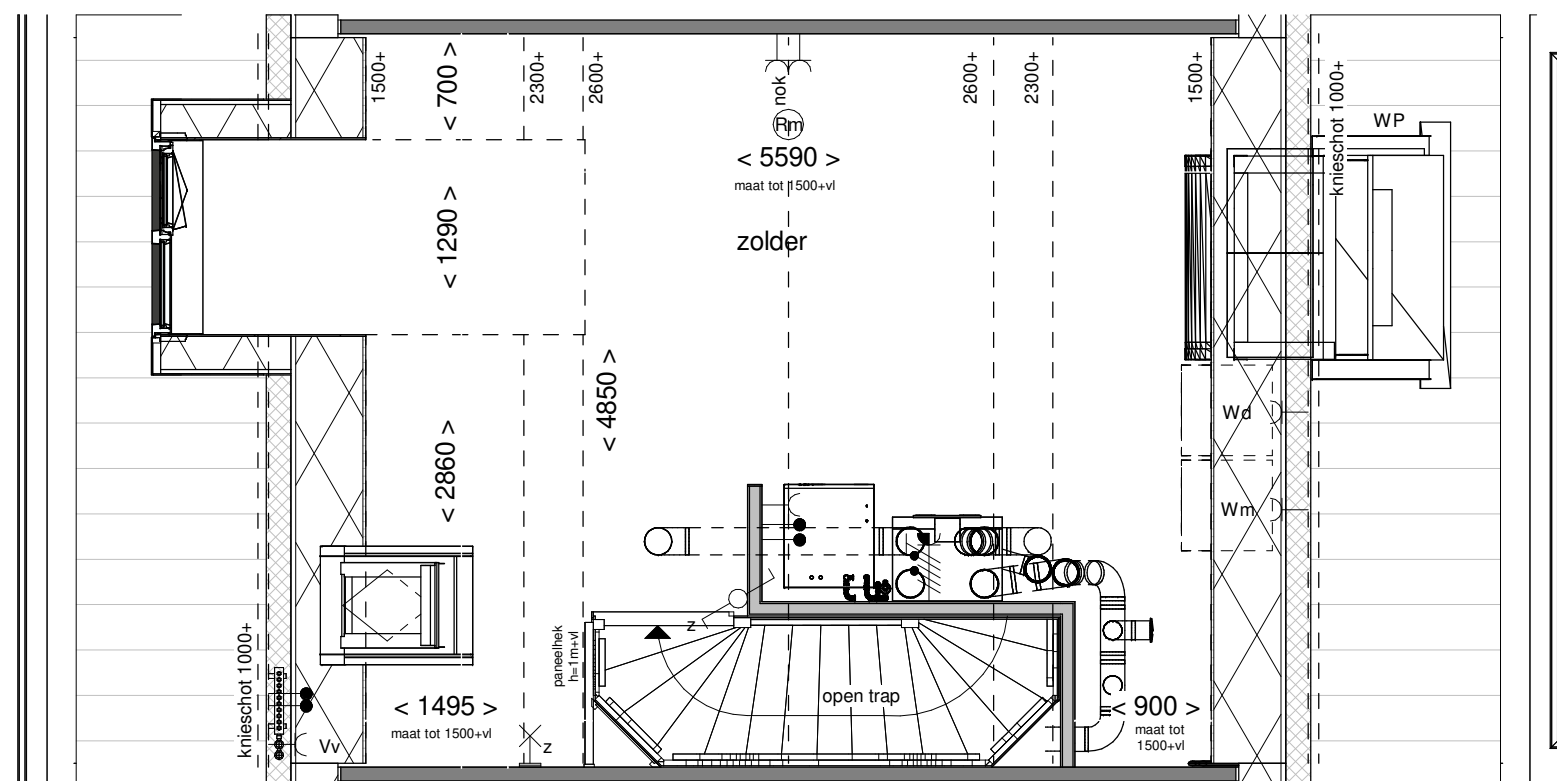

Doorsnede schaal 1:100



Achtergevel schaal 1:100



Tekening: Dakkapel achtergevel 130cm
 Woningtype: C51
 Bouwnummer: -
 Optienummer: 1.B.X.32
 Bladformaat: A3
 Schaal: 1:50 / 1:100
 Datum: 16-01-2024

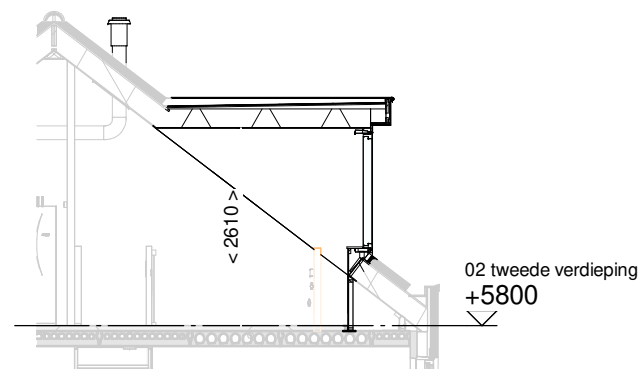
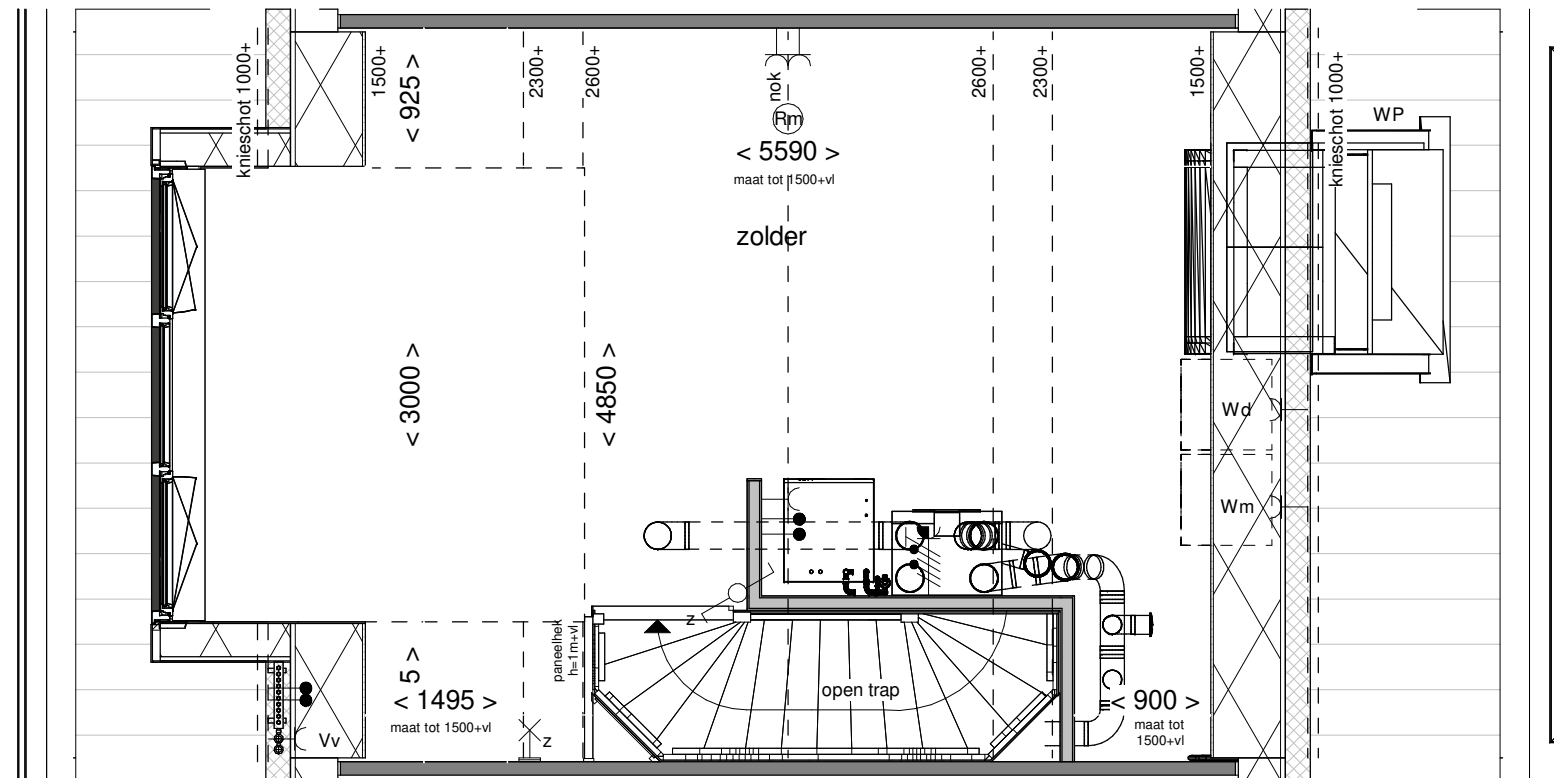

Doorsnede schaal 1:100



Achtergevel schaal 1:100



Tekening: Dakkapel
achtergevel 300cm

Woningtype: C51

Bouwnummer: -

Optienummer: 1.B.X.34

Bladformaat: A3

Schaal: 1:50 / 1:100

Datum: 16-01-2024

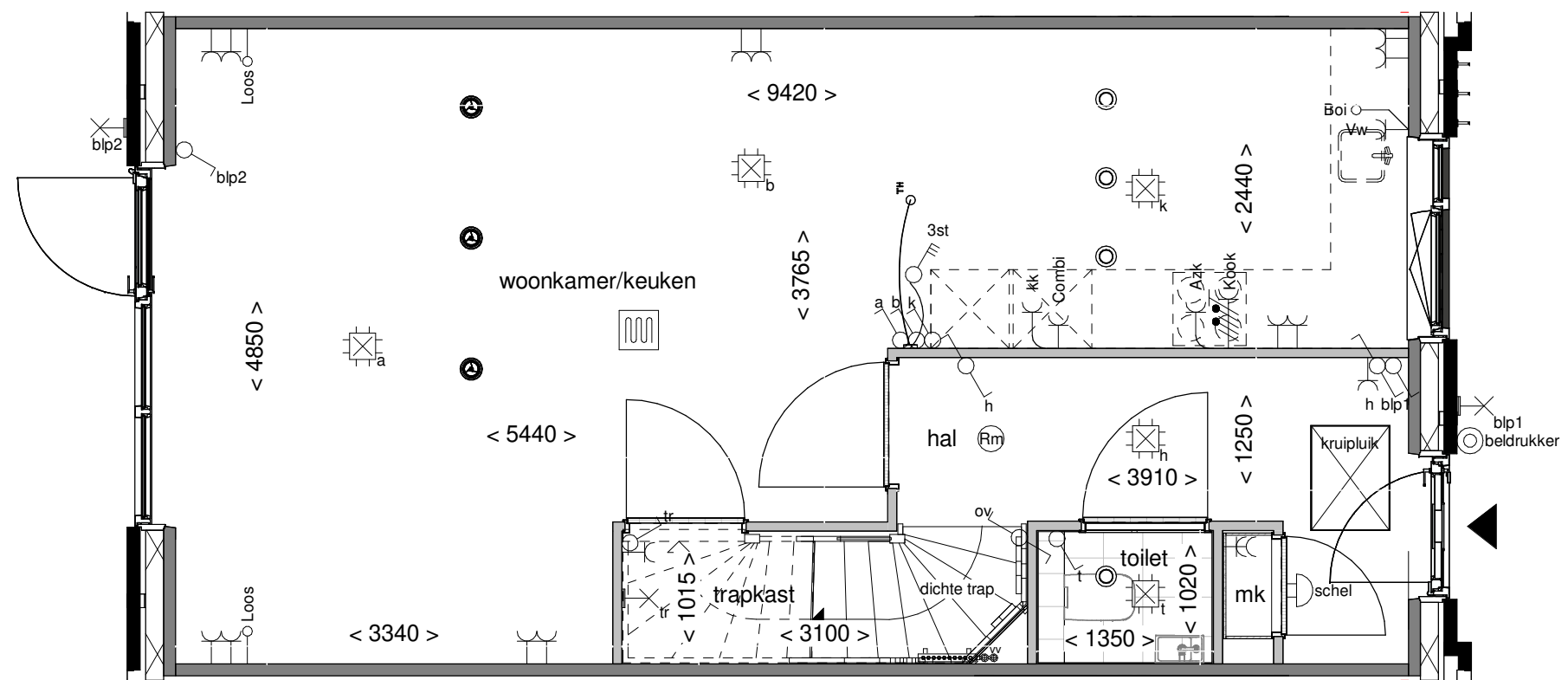

Trapkast

Tekening:

Woningtype: C51

Bouwnummer: -

Optienummer: 1.C.C.10

Bladformaat: A3

Schaal: 1:50

Datum: 16-01-2024

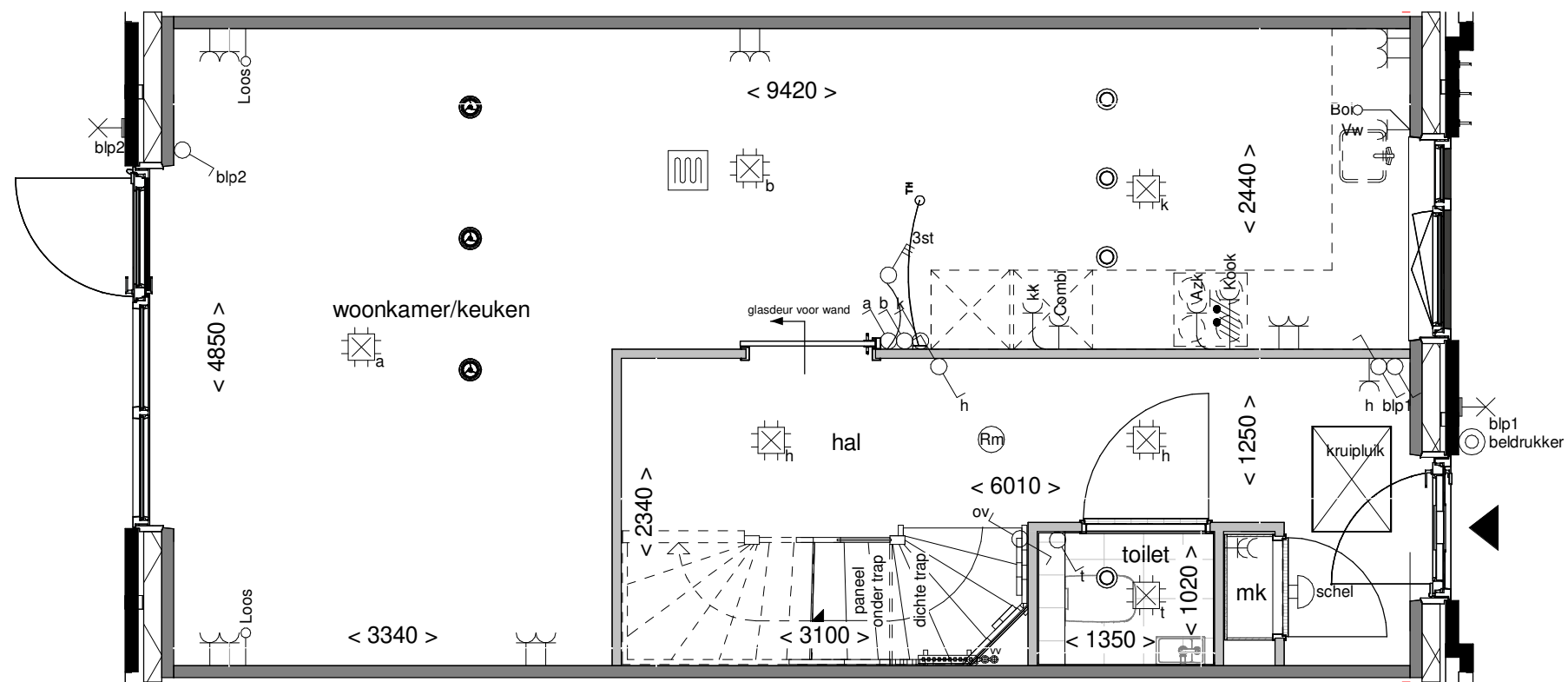

Tekening: Schuifdeur voor de wand

Woningtype: C51

Bouwnummer: -

Optienummer: 1.C.C.12 - 3.L.0.24

Bladformaat: A3

Schaal: 1:50

Datum: 16-01-2024

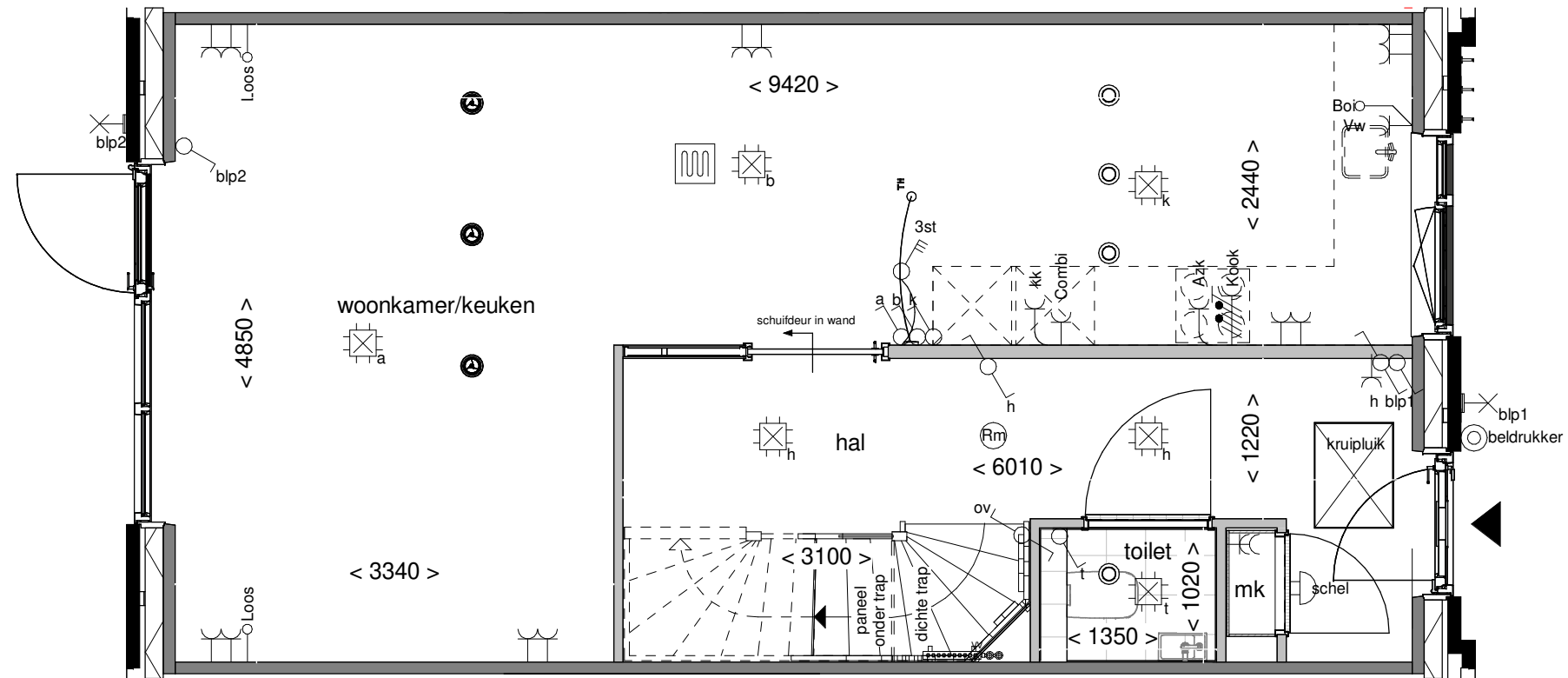

Tekening: Schuifdeur in de wand

Woningtype: C51

Bouwnummer: -

Optienummer: 1.C.C.12 - 3.L.0.26

Bladformaat: A3

Schaal: 1:50

Datum: 16-01-2024

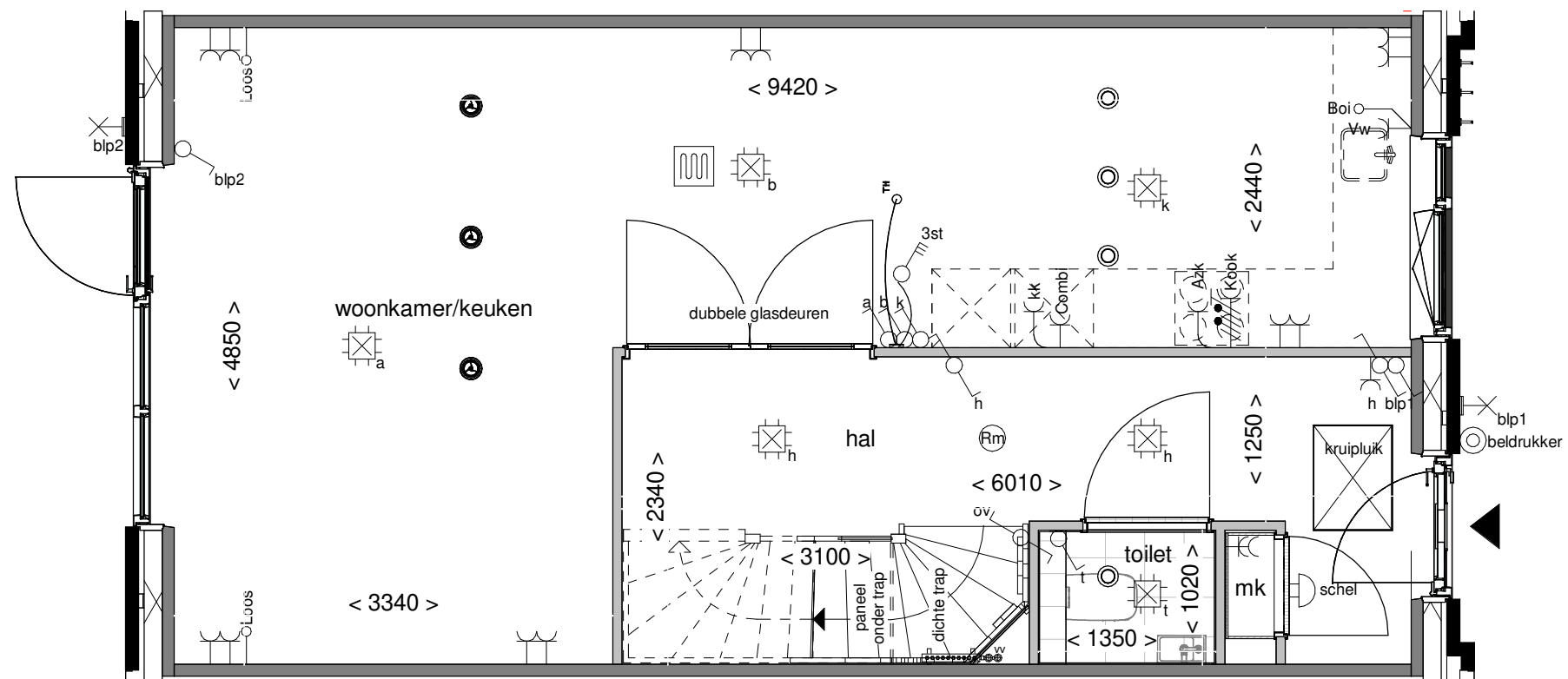

Tekening: Vergroten hal met 2 glasdeuren
 Woningtype: C51
 Bouwnummer: -
 Optienummer: 1.C.C.14
 Bladformaat: A3
 Schaal: 1:50
 Datum: 16-01-2024

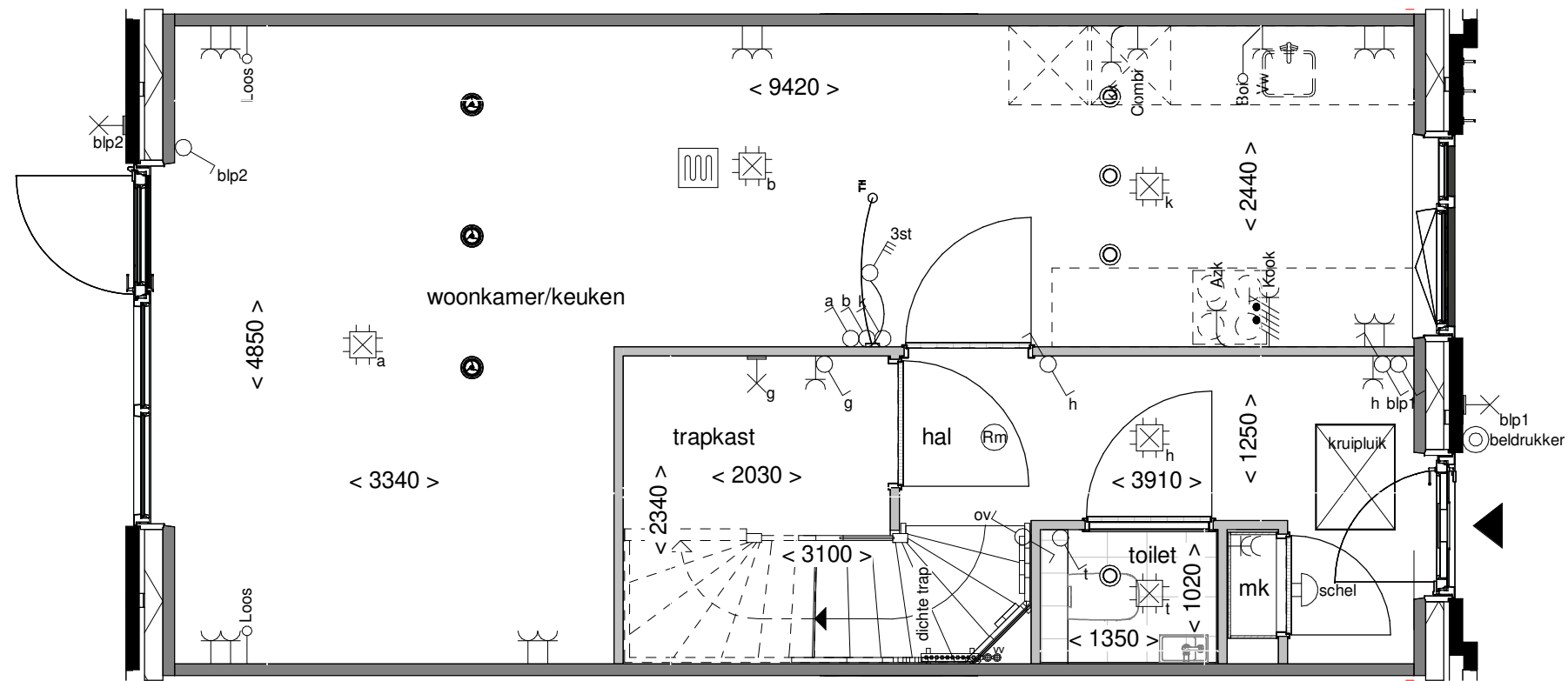

Vergroten trapkast

Tekening:	
Woningtype:	C51
Bouwnummer:	-
Optienummer:	1.C.C.16
Bladformaat:	A3
Schaal:	1:50
Datum:	16-01-2024

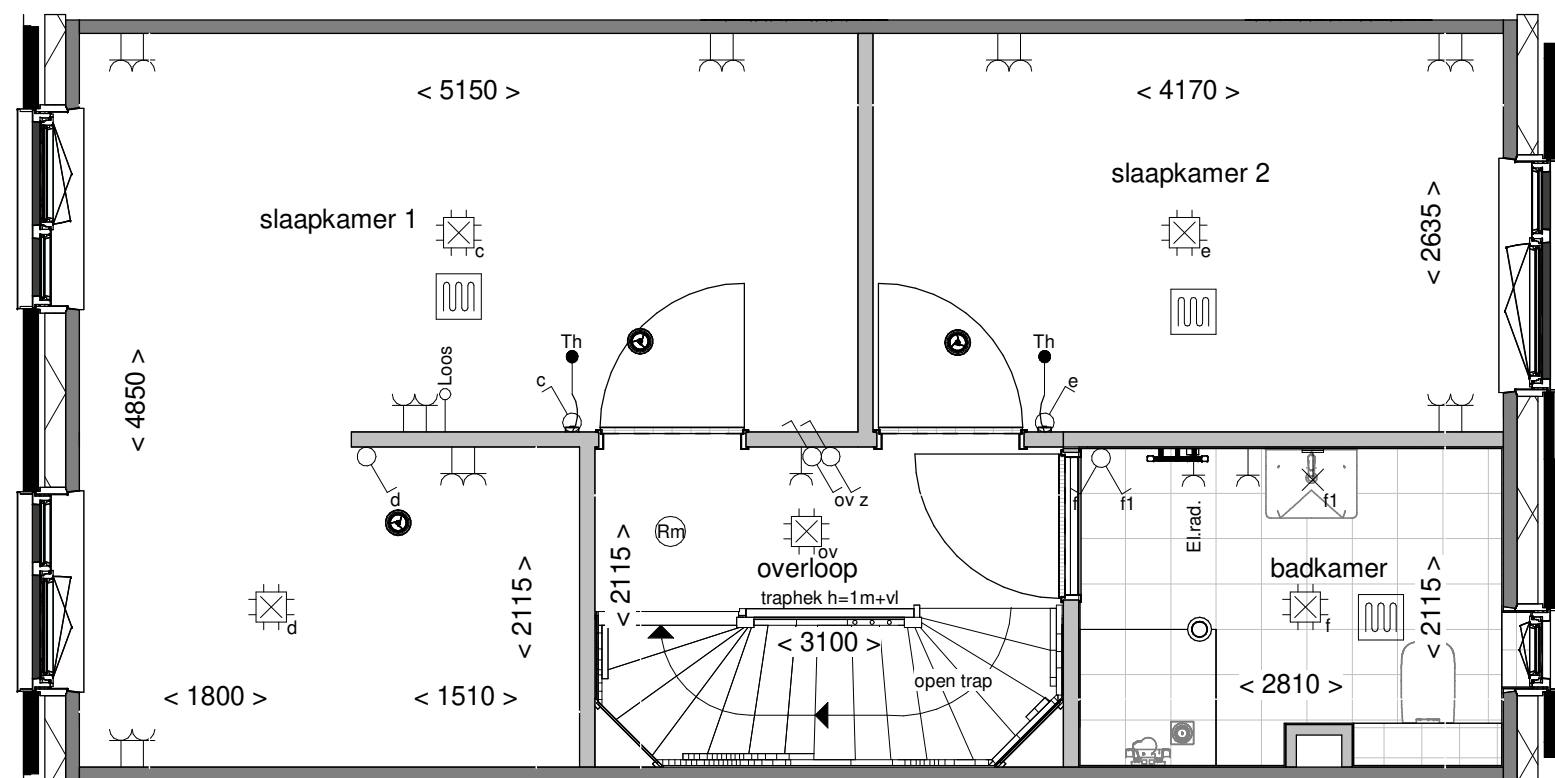

Tekening: Slpk 1 en 3 samen
voegen incl. wand

Woningtype: C51

Bouwnummer: -

Optienummer: 1.C.C.30

Bladformaat: A3

Schaal: 1:50

Datum: 16-01-2024

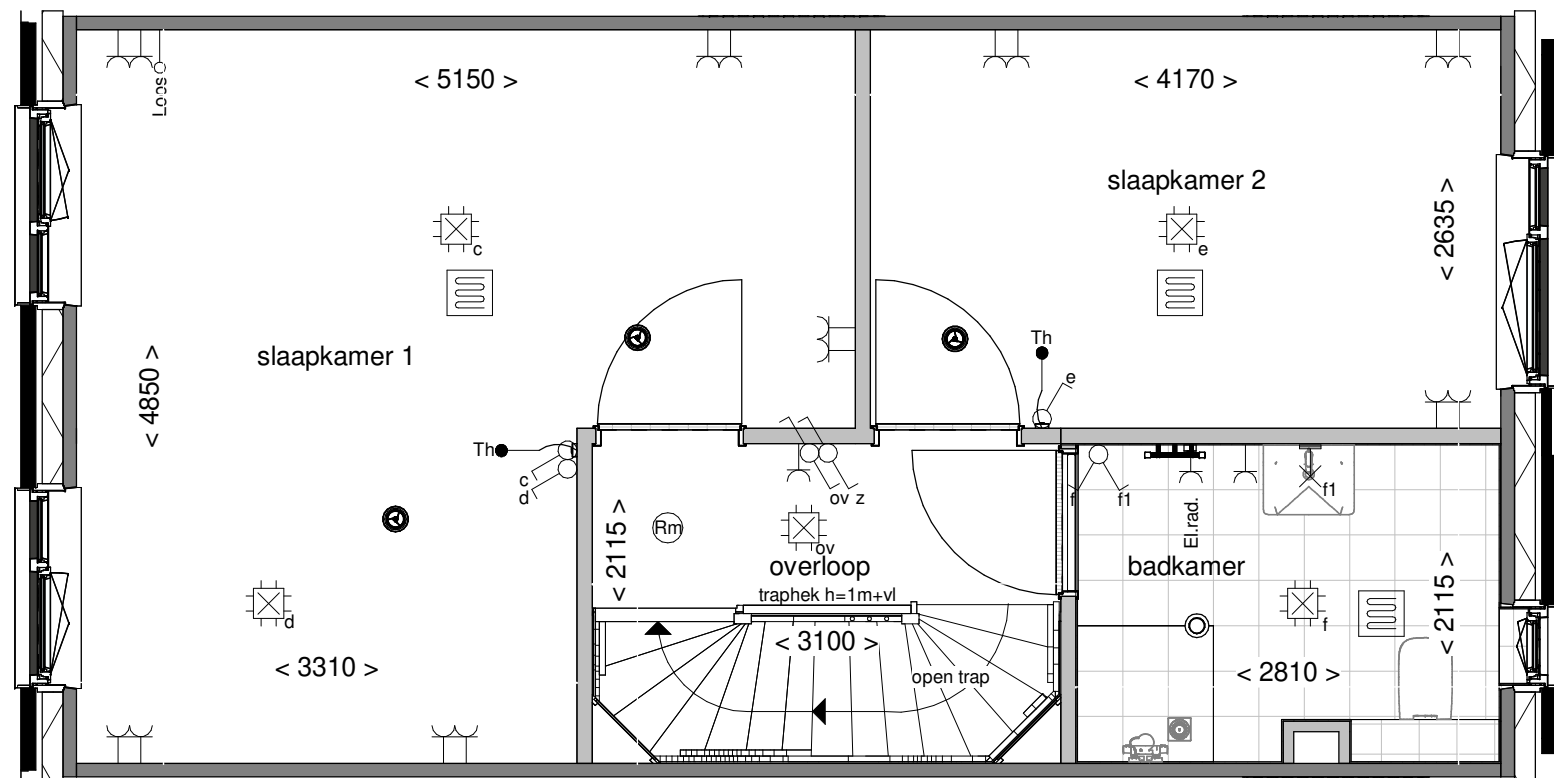

Tekening: **Samenvoegen
slaapk. achterzijde**

Woningtype: **C51**

Bouwnummer: **-**

Optienummer: **1.C.C.32**

Bladformaat: **A3**

Schaal: **1:50**

Datum: **16-01-2024**

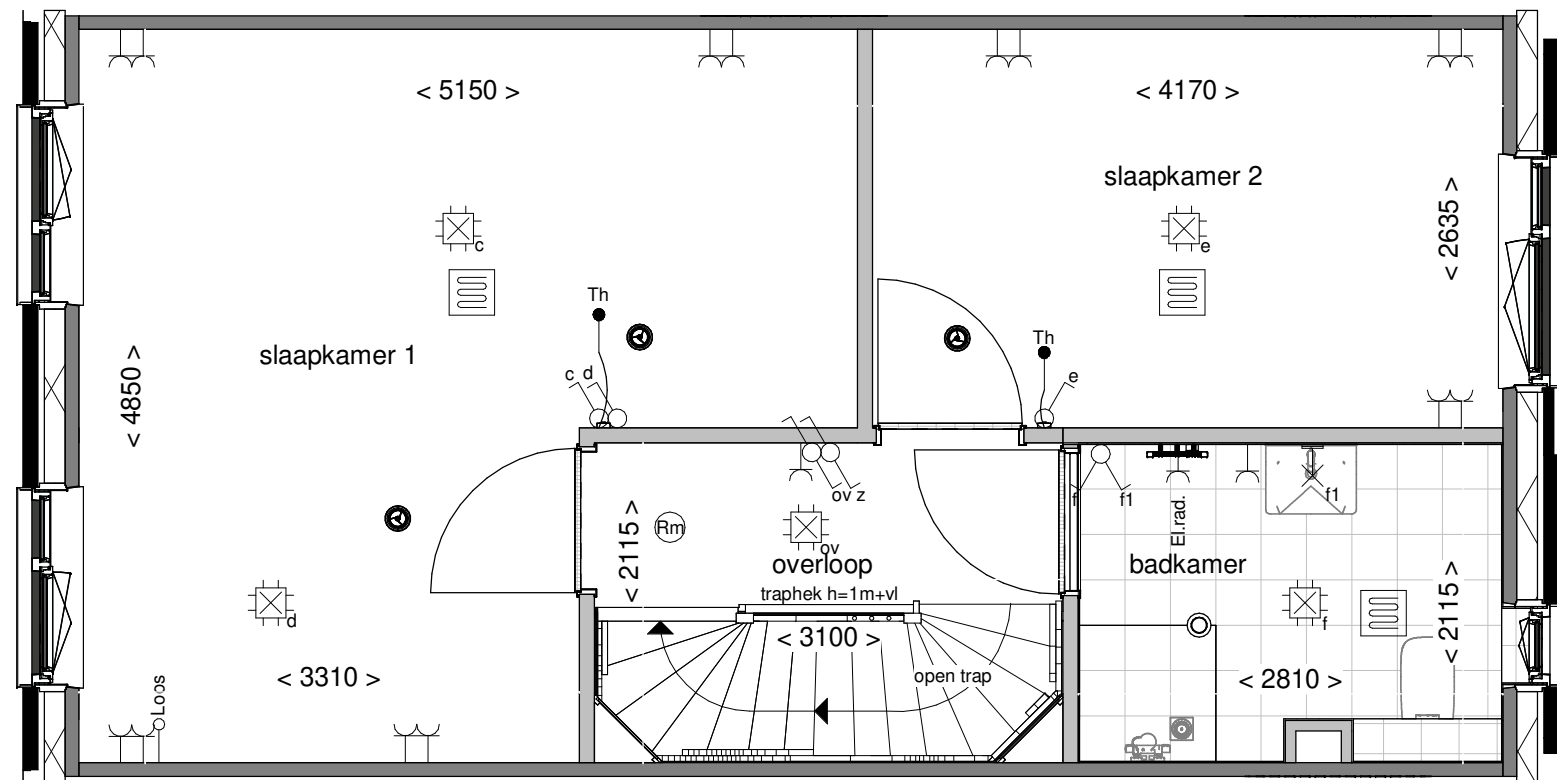

Tekening: Samenvoegen
slaapk. achterzijde

Woningtype: C51

Bouwnummer: -

Optienummer: 1.C.C.33

Bladformaat: A3

Schaal: 1:50

Datum: 16-01-2024

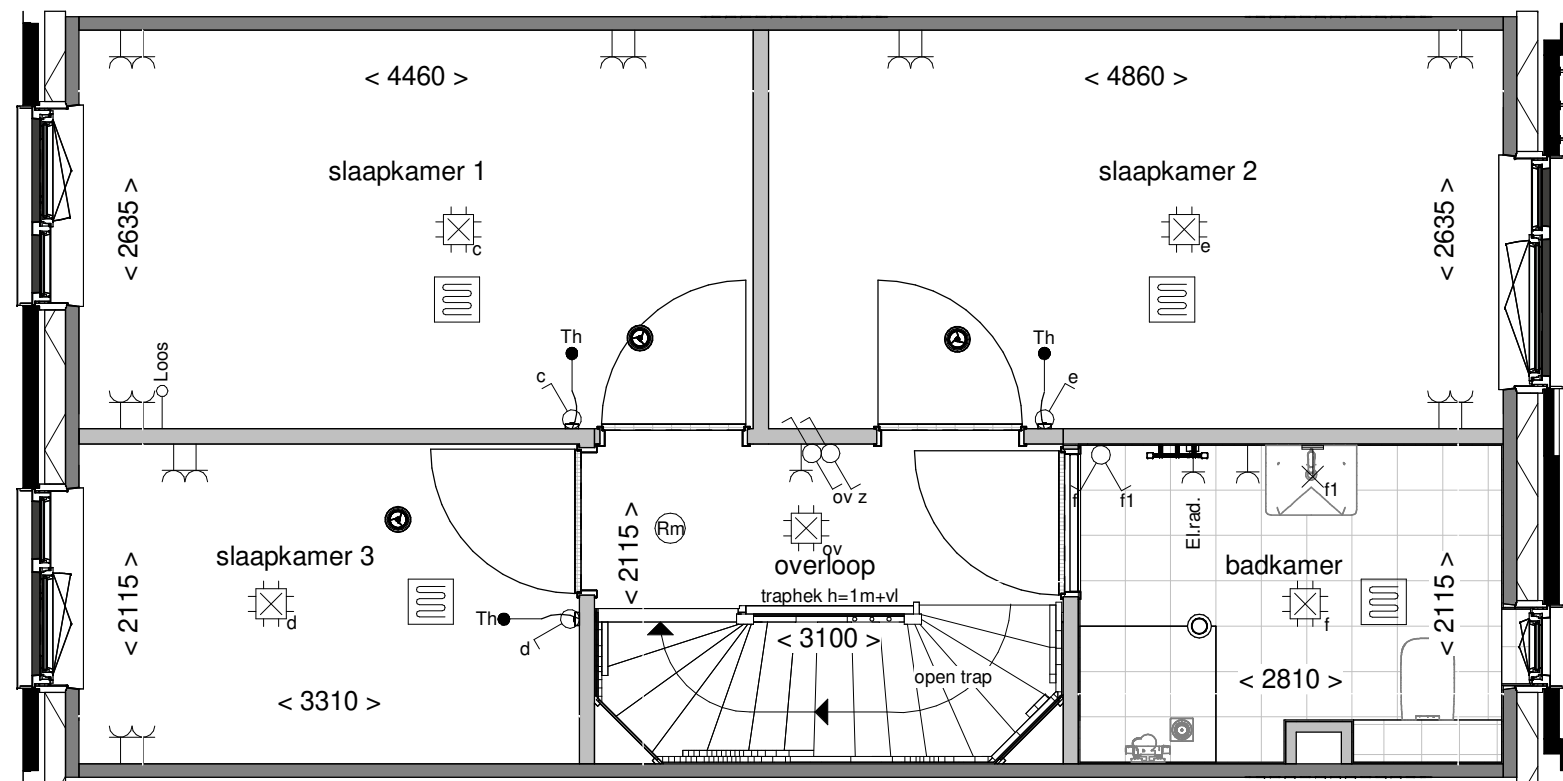

Tekening: Vergroten slaapkamer 2

Woningtype: C51

Bouwnummer: -

Optienummer: 1.C.C.34

Bladformaat: A3

Schaal: 1:50

Datum: 16-01-2024

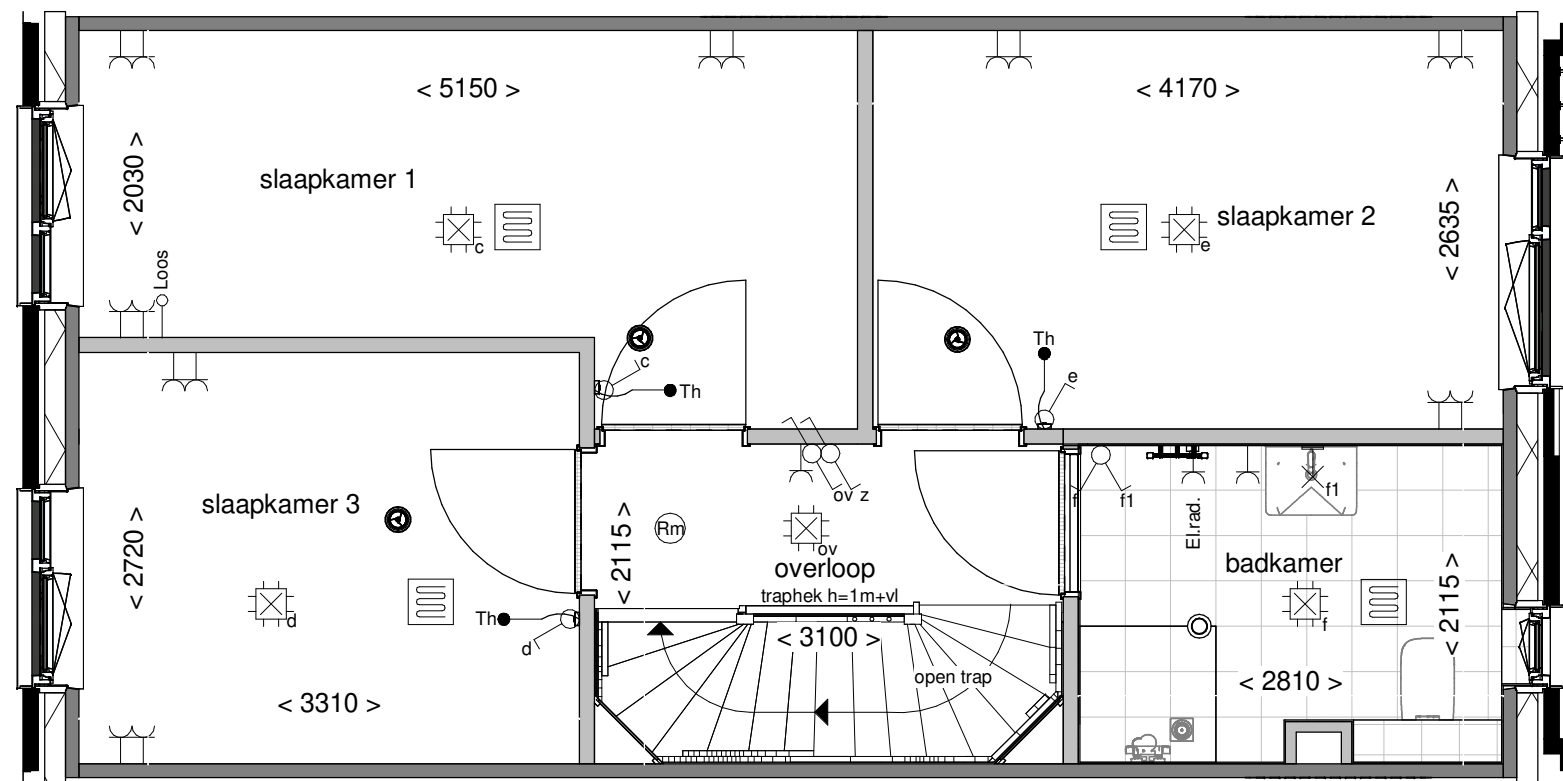

Tekening: Vergroten slaapkamer 3

Woningtype: C51

Bouwnummer: -

Optienummer: 1.C.C.36

Bladformaat: A3

Schaal: 1:50

Datum: 16-01-2024

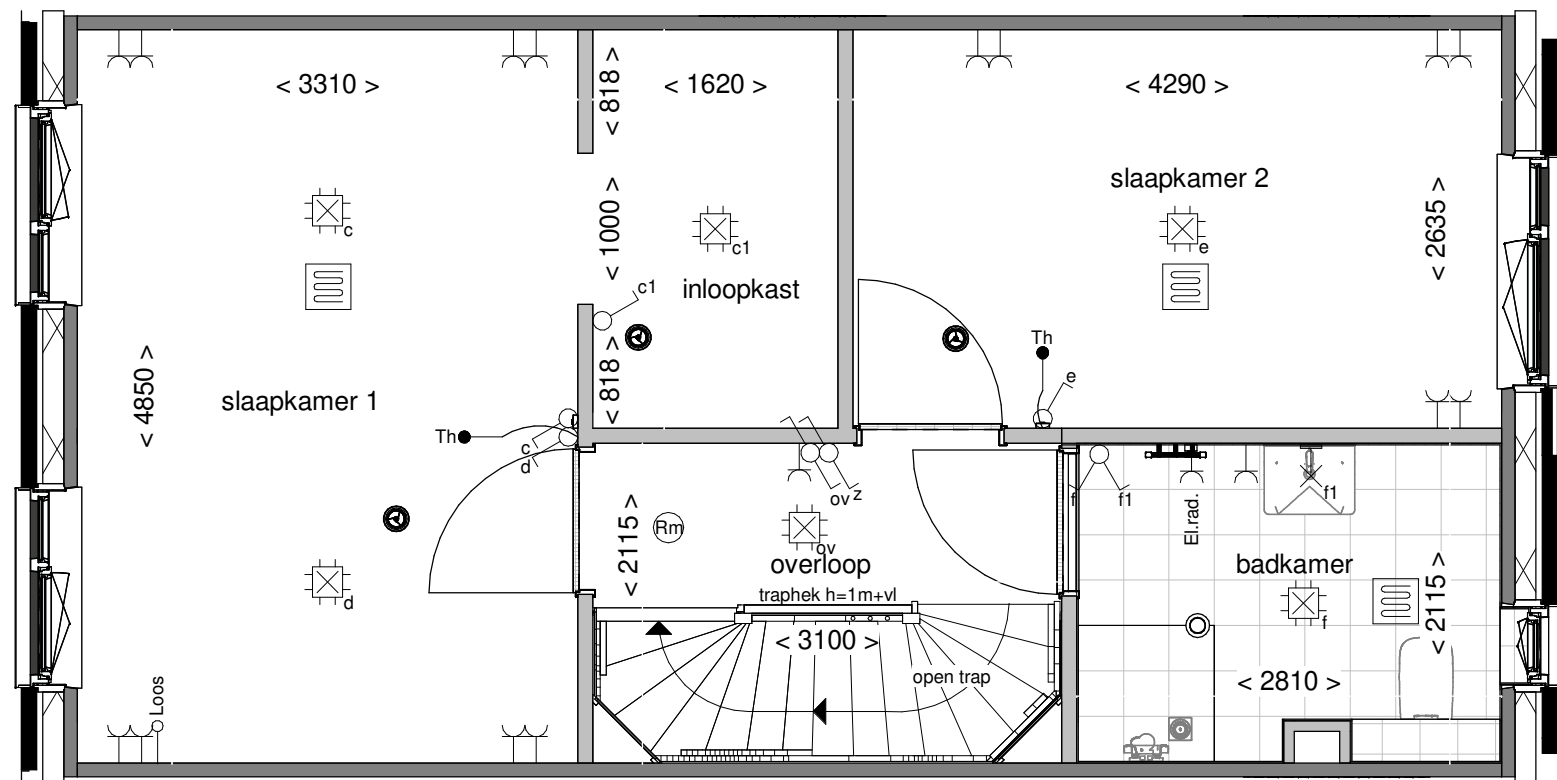

Tekening: **Inloopkast in slaapk. achterzijde**

Woningtype: **C51**

Bouwnummer: **-**

Optienummer: **1.C.C.38**

Bladformaat: **A3**

Schaal: **1:50**

Datum: **16-01-2024**

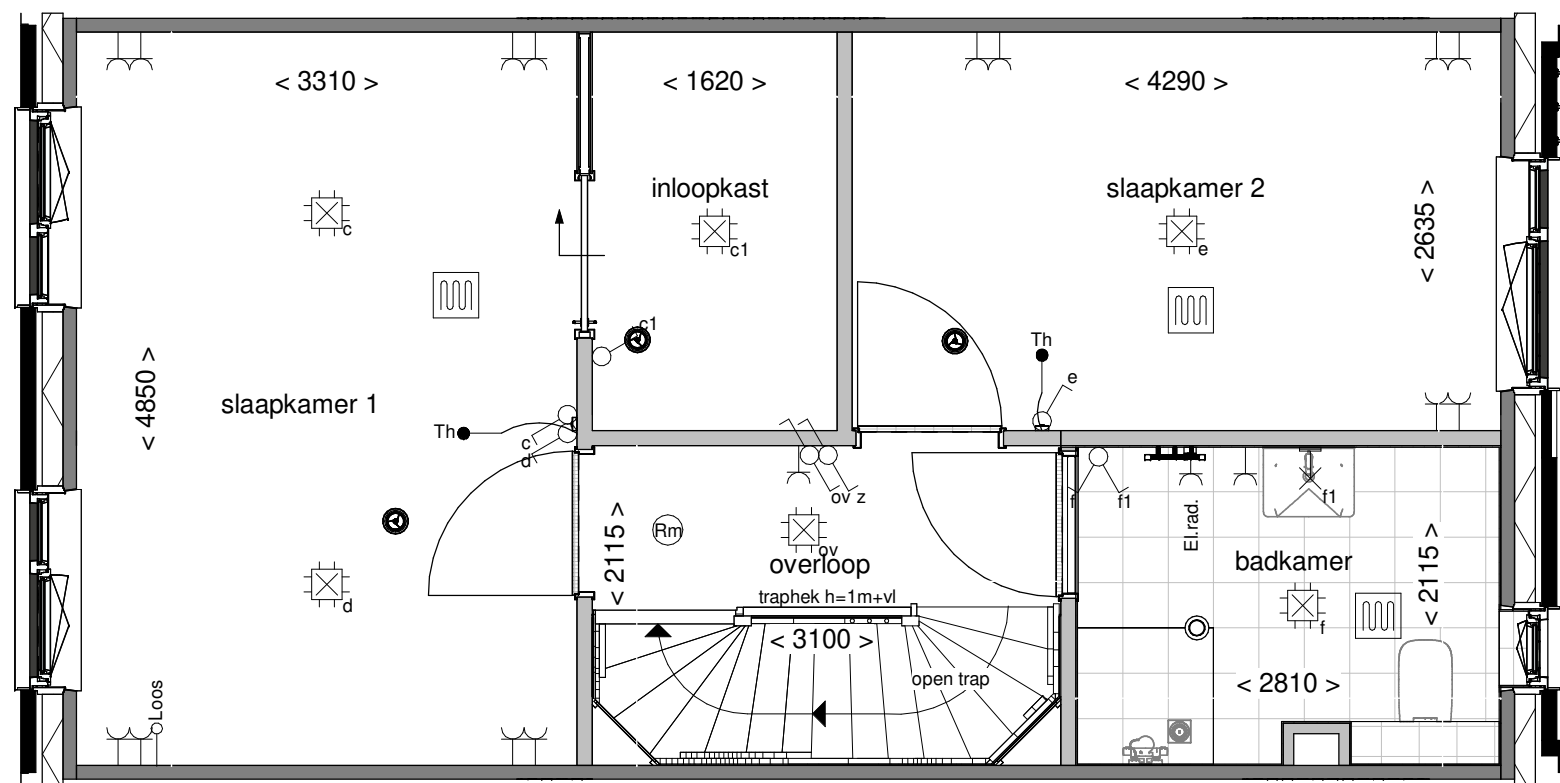

Tekening: Inloopkast + schuif-
deur slpk achter
 Woningtype: C51
 Bouwnummer: -
 Optienummer: 1.C.C.38-L24b
 Bladformaat: A3
 Schaal: 1:50
 Datum: 16-01-2024

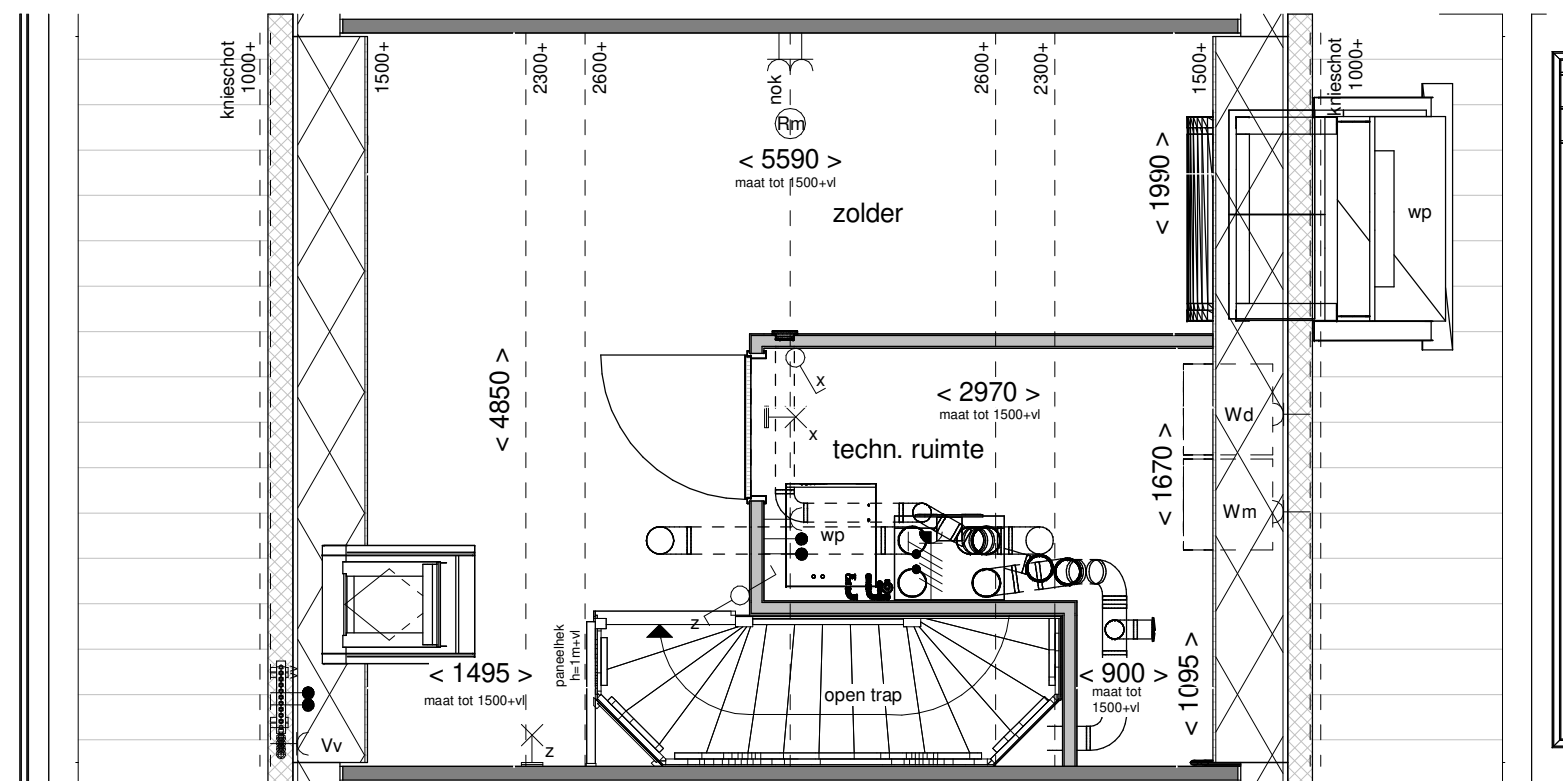

Tekening:	Indeling met techniekruimte
Woningtype:	C51
Bouwnummer:	-
Optienummer:	1.C.C.70
Bladformaat:	A3
Schaal:	1:50
Datum:	16-01-2024

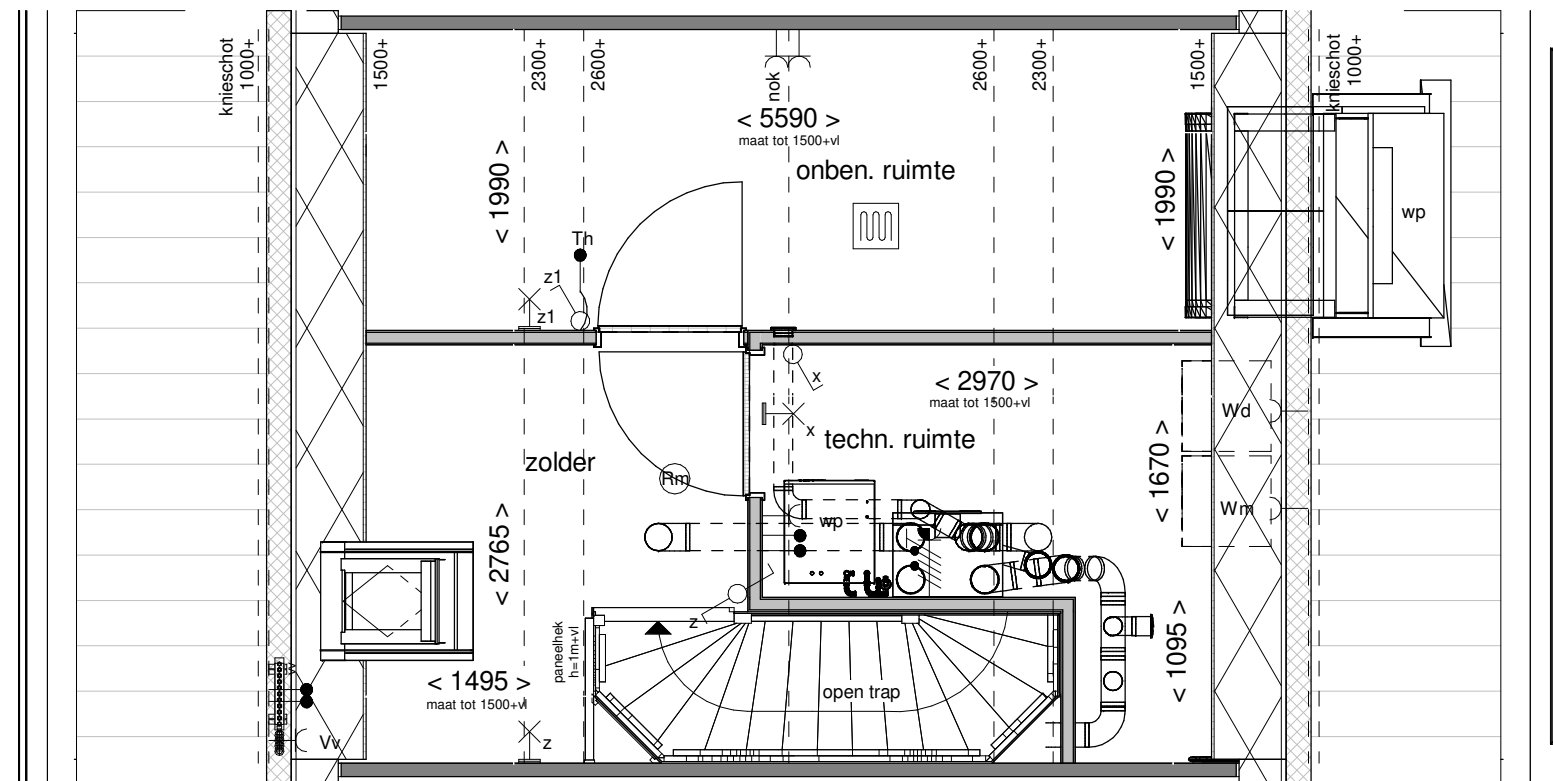

Tekening: Indeling met techn. en onben. ruimte

Woningtype: C51

Bouwnummer: -

Optienummer: 1.C.C.72

Bladformaat: A3

Schaal: 1:50

Datum: 16-01-2024

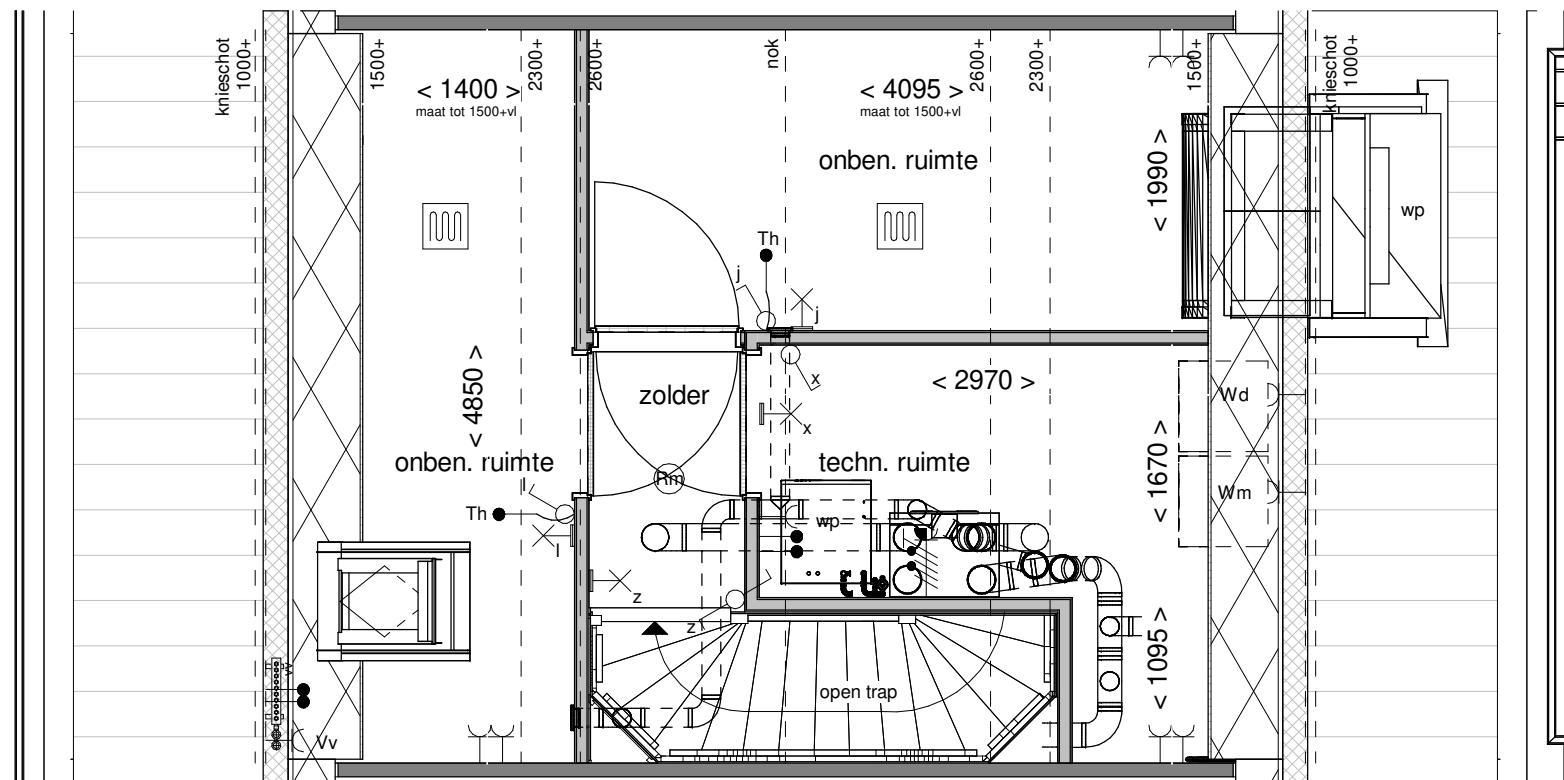

Tekening: Indeling techn.- en
2 onb. ruimtes

Woningtype: C51

Bouwnummer: -

Optienummer: 1.C.C.76

Bladformaat: A3

Schaal: 1:50

Datum: 16-01-2024